

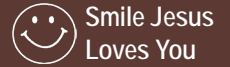

3715 Hwy 71 | Coushatta, Louisiana
 PH # 318-932-5118 | FAX # 318-932-9800

Visit our Websites
www.stevenstractor.com | www.ontimegamefeeders.com
 E-Mail - sales@stevenstractor.com

2020 EQUIPMENT CATALOG



Available in Green - Orange or Red



NEW FOR 2020!



SALVATION'S FREEWAY

ALL HAVE SINNED

"For all have sinned and come short of the glory of God." Romans 3:23

The Penalty of Sin is Death

"For the wages of sin is death; but the gift of God is eternal life through Jesus Christ our Lord. Romans 6:23

Jesus Christ Died for our Sin

"But God commendeth His love toward us, in that while we were yet sinners, Christ died for us." Romans 5:8

To Be Forgiven for our Sin, we must Believe and Confess that Jesus is lord.

Salvation comes through Jesus Christ

"That if thou shalt confess with thy mouth the Lord Jesus, and shalt believe in thine heart that God hath raised him from the dead, thou shalt be saved.

For with the heart man believeth unto righteousness: and with the mouth confession is made unto salvation." Romans 10: 9-10

It's not just saying the words that save you. Pray it, believe it, and live it. Jesus Will Change Your Life.



Prayer for Salvation

Dear Lord Jesus,
I believe You are the Son of God and died to forgive me of my sins. I know I have sinned. I ask You to forgive me. I turn from my sins and I receive You as my Lord and Savior Thank You for saving me.

Amen

Is there hope for America?

Will we become the great nation that we are capable of becoming?

Or will we slip deeper and deeper into moral and spiritual decline?

The good news is that there is hope for America! But only if we humbly bow before GOD in prayer and confession -

As Pastor Joe Wright did before the State House in Topeka, Kansas.

Will you join in this profound prayer?

If we truly pray this prayer in believing Faith we - and our nation - will never be the same.

Heavenly Father, we come before you today to ask Your forgiveness and seek Your direction and guidance.

We know Your Word says "Woe to those who call Evil good," but that's exactly what we have done.

We have lost our spiritual equilibrium and inverted our values.

We confess that:

We have ridiculed the absolute truth of Your Word and called it moral pluralism:

We have worshiped other gods and called it multiculturalism;

We have endorsed perversion and called it alternative lifestyle;

We have exploited the poor and called it lottery;

We have neglected the needy and called it self-preservation;

We have rewarded laziness and called it welfare;

We have killed our unborn and called it choice;

We have shot abortionist and called it justifiable;

We have neglected to discipline our children and called it building esteem;

We have abused power and called it political savvy;

We have coveted our neighbors possessions and called it ambition;

We have polluted the air with profanity and pornography and called it freedom of expression;

We have ridiculed the time-honored values of our forefathers and called it enlightenment.

Search us, O God, and know our hearts today; try us and see if there be some wicked way in us to cleanse us from every sin and set us free. I ask it in the name of your Son, the Living Savior, Jesus Christ,

Amen.



FORD/NEW HOLLAND



ALLIS CHALMERS



JOHN DEERE



MASSEY FERGUSON



WHITE OLIVER



CASE / DAVID BROWN



FARMALL/INTERNATIONAL

Looking for Tractor Parts?

Allis Chalmers, Bolens, Case, David Brown, Ford, International/Farmall, Kubota, Massey Ferguson, Mahindra, Mitsubishi, Satoh, Yanmar and More.

Small Farm Equipment Also Available!

Give us a Call Today at 1-800-333-9143
or check our website at
www.stevenstractor.com



Don't miss
NEW Stevens Tractor

YouTube videos! Be sure to Subscribe,

and click the bell icon  next to Subscribe to receive alerts when new videos are out!



CAMERA SYSTEMS

Back up to a hitch without the need of others
Eliminate blind spots on Air Seeders, Tractors, Sprayers, Balers, Grain Carts, Combines, Spreaders, and Skidsteers.



5" monitor with VWLCAM4 metal license plate camera
 Complete kit with 30ft cable
ORDER # VWIC500L..... \$199.00

NEW! 7" LCD monitor that can be easily connected by cigarette lighter. Great for pick up trucks!
ORDER # VWIC700-WL.....\$ 439.00



5" monitor with Upgraded 700 TVLVWCAM4/magnet base and 30 ft cable

ORDER # VWIC500 \$249.00



2 Camera Kit 10.1" Wide Monitor w/Quad to view up to 4 cams at one time. Includes 2 700TVL Cameras, 30 ft cables and remote
ORDER # VWIC104V2..... \$699.00

4 Camera Kit 10.1" Wide Monitor w/Quad to view up to 4 cams at one time. Includes 4 700TVL Cameras, 30 ft cables and remote
ORDER # VWIC104V4..... \$939.00



7" monitor with Upgraded 700 TVLVWCAM4/magnet, 30 ft cable, remote, two inputs
ORDER # VWIC700 \$299.00

In the same way, let your light shine before others, that they may see your good deeds and glorify your Father heaven.
 — Matthew 5:16

Additional Cameras, Cables, and Accessories are also available.

CAMERA BUNDLES

FITS: OEM Factory GPS Monitors

It is important to find out if your GPS system has video inputs and the proper harness for these kits



Add a Camera/Cable Bundle to your Tractors GPS Monitoring System.

Includes: Camera, Wiring Adaptor, Mounting Bracket and 30ft Cable

These bundles include the camera, cable and connections that plug right into your existing GPS System. This system allows you to monitor your surroundings with minimal effort. You can also add the wireless adaptor kit to any camera then mount the camera in or on any piece of equipment behind or near your tractor up to 300 ft with a good line of sight. *See Application Chart Below*

OEM SYSTEM APPLICATION	ORDER #	PRICE
Trimble/Case/NH/FMX1000 and CFX750	VWCAMBN-TR	\$185.00
Raven Viper 4, TeeJet Matrix, Autofarm, AG Leader Integra, Topcon, Outback Max	VMCAMBN-CX	\$185.00
John Deere2630 and touch screen Command Centers on 2014 + models	VWCAMBN-JDR	\$185.00
CASE PRO 700 models, and NH Intelliview IV models	VWCAMBN-CASE7	\$185.00
PAL Camera fits AGCO monitor and prewired balers	VWCAMBN-CX-PAL	\$185.00
(FLAGSHIP) CASE and NEW HOLLAND 2014 and newer Combine	VWCAMBN-CNHC	\$185.00



Wireless Camera Adaptor Kit

ORDER # VWW24 \$ 219.00

Make any of our cameras **WIRELESS**. This kit transmits the video signal up to 300 ft. with a good line of sight.

With uncompromising attention to detail and unwavering devotion to quality production standards, Helton has developed the strongest, most durable tractor top on the market. We're so certain of the superior quality of our tops that each one is backed by a lifetime warranty against color fading from the Manufacturer.

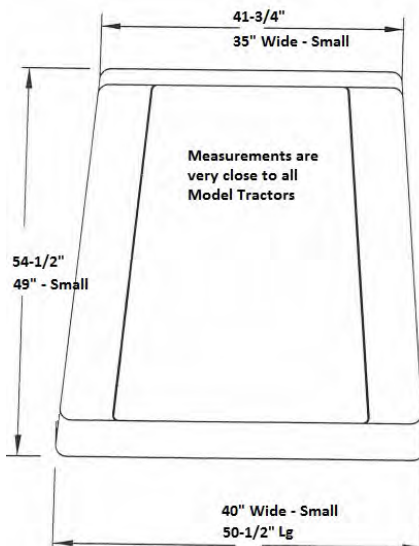

Large Size Canopies in Stock.
Small Size Must Be Ordered.

FEATURES

\$ 475.00

STRENGTH: 12-gauge, full structure, tubular steel frame topped by heavy-duty, high impact hard top. No other top on the market compares!

***CAUTION:** The Helton top does not protect the operator in the event of a rollover.

DURABILITY: Made from UV resistant plastic with high impact resistance. Rust and UV resistant.

EASE: Canopy removal is not required when transporting vehicles. Helton tractor tops are designed to handle highway speeds of 55 m.p.h. while transporting.

- ORDER # TOP-LGB** Large Blue
- ORDER # TOP-LGO** Large Orange
- ORDER # TOP-LGG** Large Green
- ORDER # TOP-LGR** Large Red
- All Canopies MUST Ship By Freight Truck.**
- Call For a Quote Today!**



DELUXE UMBRELLA

Complete Cover, Bracket & Frame.

Each Corner Reinforced With Leather And Provided With Heavy Steel Grommets. Umbrella Cover, 54" Square, Made Of Heavy Double - Stiche 8 oz. Double - Filled Duck. Choose Your Color



- Red**
- ORDER # TU56R \$ 159.95
- Blue**
- ORDER # TU56B \$ 159.95
- Yellow**
- ORDER # TU56Y \$ 159.95

Replacement Cover ONLY For Umbrella

- Red**
- ORDER # TU56CCR \$ 67.95
- Blue**
- ORDER # TU56CCB \$ 67.95
- Yellow**
- ORDER # TU56CCY \$ 67.95

BRACKET ONLY

For Umbrella

FITS: All Tractors, Industrial Equipment And Combines. Can Be Installed In A Matter Of Minutes Without Drilling Holes Or Otherwise Changing The Equipment



ORDER # 405200..... \$ 45.95

ROPS UMBRELLAS

54" Square Water Resistant Cover Comes with Universal Mounting Bracket to Mount Directly to Rollover Bar.

FITS: ROPS from 2" X 2" to 3" X 3"



- Blue**
- ORDER # 405941..... \$ 169.95
- Red**
- ORDER # 405943..... \$ 169.95
- Yellow**
- ORDER # 405944..... \$ 169.95
- Orange**
- ORDER # 405942..... \$ 169.95

S M V EMBLEMS

Emblem On Metal Back
ORDER # SMV1C



\$ 12.95

Emblem On Plastic Back
ORDER # SMV1PC

\$ 12.95

Spade Mounting ONLY
Does NOT Include Socket (SMV5)
ORDER # SMV7



\$ 3.95

Mounting Socket With Nuts & Bolts For SMV7 Spade Mounting
ORDER # SMV5



\$ 3.50

Pole Mount Assembly ONLY
ORDER # SMV6



\$ 6.95



GOOSENECK HITCH



Designed for tractors 50 HP & up. Heavy angle iron & tubing. Has three 3/4" holes for various attachments & a 2-5/16" ball. Primary use is used in moving empty Gooseneck type trailers where a truck is not feasible.

Complete with Cat 2 lift pins. Wt. 65 lbs.

ORDER # GNH.....\$ 225.00

With 2" Receiver

ORDER # GNH-WR\$ 255.00

You also must be patient. Strengthen your hearts, because the Lord's coming is near.

—James 5:8

FAST HITCH

Fast Hitch Will Not Roll or Turn.



The Fast Hitch is Ideal for towing trailers, & moving trailed implements.

Standard Fast Hitch is Constructed of heavy angle iron & 2" tubing. It has three 3/4" holes for a variety of mounting Trailer Balls, Clevises, Drawbar Hooks, etc. Optional- Not Included.

Fast Hitch With Receiver is made of Heavy 2" square tubing and receives all standard 2" hitches. Both Come with Cat 1 pins | Ships FedEx, Wt. 30lbs.

ORDER # FH.....\$ 99.00

Fast Hitch With Receiver

ORDER # FHWR.....\$ 78.95

OPTIONAL Accessories

Heavy Duty Drawbar Grab Hook

ORDER # B834.....\$ 26.95

2" chrome Hitch Ball 3500 lb. Cap.

ORDER # 3205C.....\$ 9.95

Heavy Duty 3/4" Clevis

ORDER # B465.....\$ 14.95

EZ HITCH

FEATURES

- EZ Hitch allows you to hook up to different width implements
- Implements on unlevel ground are easily hooked up
- Works on all implements
- Installs on all lift arms with or without pull outs
- **Includes Stabilizer Bar**

SIZES AVAILABLE (Priced Per PAIR)

Includes Stabilizer Bar

Cat.1: Pins with 7/8" diameter.

ORDER # EH102WB.....\$ 174.95

Cat.2: Pins with an 1-1/8" diameter

ORDER # EH202WB\$ 189.95

Other Models Available. Cat 1 to 2, Cat 2 to 1, Cat 2 to 3

HOOKING UP IMPLEMENTS MADE EASY



The EZ Hitch

Stabilizer Bar ORDER # EH-SB\$ 21.50

We Also Carry Replacement Washers and Parts



Easy Installation

Fits Over Your Lift Arm

For replacement EZ Hitch parts see page 87



TRAILER SPRAYERS

QUALITY STANDARD FEATURES:

Pump: Hypro 8 Roller Pump Capacity. 11.4 GPM, 150 PSI at 540RPM. *Quick Connect Coupler.*

Tank: Heavy Duty 325 Gallon Poly with UV inhibitors with 16" fill well for easy filling. Screw on Vented Cap.

Hand Gun: High Pressure 800 PSI, Hamilton 13" Pistol Grip. Adjustable for fan or stream spraying. Spray streams up to 40 Ft.

Hose: All Hose is working Pressure 200 PSI, Gun Hose is 1/2" x 50 Ft., Pump Hose is 3/4".

Boomjet Nozzle: Wide arc cluster nozzle. Spray coverage up to 40 Ft. With Shut Off Valve.

Trailer: Heavy angle iron with 3500Lb axle. New 15" tires, jack stand, flooring 2" treated pine. Low Profile. Length 121" Width 67" - Height 17".

Sprayer includes regulator valve, gauge, Pump adapter, mounting bracket, filter, Operators and Parts manual, Nothing extra to purchase.

ORDER # CS325T Weight 595 Lb.\$ 2475.00

\$ 2475.00



Comes Standard



OPTIONAL: Kickback Boom Assembly, 15 Ft. Coverage with 9 nozzles on 20" centers. (8 Ft. Pictured).

NOTE: Boom DOES NOT actually measure 15 Ft., this is the spray coverage. **ORDER # CS150B\$ 185.00**

PULL TYPE SPOT SPRAYERS

Tow Behind

Lawnmower - ATV - Garden Tractor

FEATURES:

Same as the other Spot Sprayers



Frame: Constructed of Heavy Gauge Square Tubing with Large Tires 600 x 6 x 15" OD.

25 Gallon ORDER # SS25TM \$ 389.95

OPTIONAL BOOM ASSEMBLY

8 Ft. Coverage

With 5 Teejet Nozzles on 20" Spacing.

ORDER # SSBA.....\$ 140.00

The Boom Assembly allows controlled spraying of large areas. Great for Gardens and Lawns. The Boom features a Kickback Feature. Should the boom strike anything, it will fold back preventing any damage.





55 GALLON

STANDARD FEATURES:

- Pump:** Hypro 6 roller pump with Quick Connet. It has a maximum flow of 7.4 GPM, 150 PSI at 540 RPM.
- Tank:** Tough 55 gallon poly tank with tank strainer and agitator. Large 5" tank opening for easy filling, screw on vented cap.
- Frame:** Heavy Duty low profile sturdy design 3Pt. Hitch frame. Cat 1 pins. Metal tank straps.
- Hand Gun:** 13" Pistol Grip Spray Gun Sprays stream up to 40ft. Gun hose 1/2" x 25 Ft
- Hose:** Red Ultra Flex 200 PSI
- Nozzle:** Boomless # BN5 on rear of frame that covers 35ft spraying width with shut off valve.
- SIZE:** Width 39", Depth 26", Height 38"

Sprayers includes regulator valve, gauge, pump & adapter, mounting bracket, filter, Operators and Parts manual, Nothing extra to purchase.

ORDER # CS55D
Weight 125 lb\$ 945.00

Broadcast Nozzle

ORDER # BN5

Standard on the 55 & The Economy 150 Gallon. Spray Coverage 35 Ft.



TRACTOR P T O SPRAYER KIT

IDEAL FOR SPRAYING

Fence Rows | Orchards | Livestock | Buildings | Gardens

Kit Consists Of:

- Pump:** Hypro 6 Roller operates at speeds up to 1000 RPM, Output at 540 RPM, 7.4 GPM, 150 PSI. Quick Connect Coupler
- Hand Gun:** 13" Pistol Grip Spray Gun Sprays stream up to 40ft. Gun hose 1/2" x 25 Ft
- Hose:** Gun Hose 1/2" x 25 Ft., Suction Hose 3/4" x 8 Ft. Discharge Hose 3/4" x 6 Ft. Bypass Hose 1/2" x 6 Ft. Working Pressure 200 PSI.
- Other:** Regulating valve, pressure gauge, pump adapter, With mounting bracket, all fittings and strainer. Simple, Easy Assembly with instructions and Operators manual.



**All You Need
 Is A Tank &
 A Tractor.**

ORDER # CSK6 **Weight 23 Lb.....\$ 369.95**



3PT TRACTOR SPRAYERS

150 GALLON SPRAYERS

STANDARD FEATURES:

- Pumps:** Hypro Roller Pumps - Quick Connect Coupler
- Tank:** Heavy Duty Poly with UV Inhibitors
- Frame:** Heavy Duty 3 Point Hitch
- Hand Gun:** 13" Pistol Grip Spray Gun
- Hose:** Red Ultra Flex 200 PSI

Sprayers includes regulator valve, gauge, pump & adapter, mounting bracket, filter, Operators and Parts manual, Nothing extra to purchase.



Broadcast Nozzle
ORDER # BN5

Standard on the 55 & The Economy 150 Gallon. Spray Coverage 35 Ft.



Boomjet Nozzle
ORDER # 5880

Standard on the Deluxe 150 Gallon. Spray Coverage 40 Ft.

150 GALLON ECONOMY

Same Features as The 55 Gallon. Same heavy duty 3 point hitch frame as the Deluxe 150 Gallon. Provides a larger Capacity at an economical price.

Economical design on heavy duty 3Pt. Hitch frame. Cat 2 pins. Features a tough 150 gallon poly tank with external filter and agitator. Large 10" tank opening for easy filling, screw on vented cap. Hypro 6 roller pump has a maximum flow of 7.4 GPM, 150 PSI at 540 RPM. Complete with 13" Pistol Grip Spray gun. Sprays stream up to 40ft. Gun hose 1/2" x 25 Ft. Broadcast nozzle # BN5 on rear of frame that covers 35ft spraying width with shut off valve. **SIZE:** Width 54", Depth 37", Height 44".

ORDER # CS150E **Weight 285 lb.....\$ 1299.00**

150 GALLON DELUXE

Heavy duty, low profile design with Cat 2 pins. Hypro 8 Roller pump has a maximum flow of 11.4 GPM. 150 PSI at 540 RPM. Complete with 13" Pistol Grip Spray gun with 1/2" x 50 Ft of hose. Large 10" screw on vented lid makes filling quick and easy. Boomjet Wide Arc Cluster Nozzle # 5880 gives 40 Ft. spray coverage. **SIZE:** Width 54", Depth 37", Height 44".

ORDER # CS150D **Weight 295 lb.....\$ 1535.00**

KICKBACK BOOM

Assemblies OPTIONAL

Boom Folds Back should you strike an obstacle

- 8 Ft. Coverage with 5 Nozzles | **ORDER # CS55B\$ 140.00**
- 15 Ft. Coverage with 9 Nozzles | **ORDER # CS150B\$ 185.00**

NOTE: All nozzles are 20" on center. Booms Do NOT actually measure 8 & 15 Ft., this is the spray coverage.





**15 OR 25 GALLON
ECONOMY SPRAYERS**

FEATURES:

- Polyethylene Tank
- In Tank Filter System
- 12 Volt Pump; 1.0 G.P.M; 35 P.S.I.
- Handgun Sprays Up To 15'
- 8' Of 3/8" Rubber Hose
- 10' Wire Harness W/ Battery Clips
- Tank Drain



15 Gallon
25 Gallon

ORDER # M-SS15COOP \$ 124.95
ORDER # M-SS25COOP \$ 134.95



15 Gallon
25 Gallon

ORDER # M-SS15..... \$ 189.95
ORDER # M-SS25..... \$ 199.95

**15 OR 25 GALLON
STANDARD DUTY**

Heavy Duty And Dependable

FEATURES:

- Polyethylene Tank
- In Tank Filter System
- 12 Volt Shurflo Pump W/ Toggle Switch; 2.2 G.P.M; 100 P.S.I.
- 18" Handgun W/ Adjustable Pattern Tip;- Maximum Horizontal - 30 Feet
- Maximum Vertical - 18 Feet
- 15' Of 3/8" Rubber Hose
- 10' Heavy Duty Wire Harness With Battery Clips
- Tank Drain

55 GALLON SPOT SPRAYER

FEATURES:

- Gallon Corrosion Resistant Polyethylene Tank
- Inline Deluxe Strainer For Easy Access and Cleaning
- By-pass Agitation Valve
- 12 Volt SHURflo Pump With Toggle Switch; 2.2 G.P.M; 100 P.S.I.
- Spraying Systems 43LA-AL Hand gun Sprays 30' To 40'
- 15' of 3/8" Rubber Hose
- 15' Heavy Duty Wire Harness With Battery Clips
- Tank Drain



**LOTS OF UPGRADES
FOR 2020**

55 Gallon

ORDER # M-SS55..... \$ 399.95



KICKBACK BOOM ASSEMBLIES OPTIONAL

8 FT. & 15 FT. COVERAGE

Coverage: 8 ft. with 5 Teejet nozzles on 20" spacing. 15 ft. with 9 Teejet nozzles on 20" spacing

Kickback Feature: Should Boom strike an object, it simply folds back to Prevent damage. Great for Transporting.

Constructed of 1" 16 gauge Sq. Tubing Assembly. Simple-Quick & Easy. With Instructions



8 Ft. Coverage

ORDER # CS55B ATV \$ 140.00



15 Ft. Coverage

ORDER # CS150B-ATV \$ 185.00

SPRAYER PUMPS



To Fit Many Different Model Sprayers.

1.0 GPM - 35 PSI 3/8" Female Ports
ORDER # 527-5086 \$ 58.95

1.8 GPM - 60 PSI 3/8" Female Ports
ORDER # 8007-593-836 \$ 97.95

2.1 GPM - 100 PSI 3/8" Female Ports
ORDER # 8007-594-838 \$ 98.95

2.2 GPM - 100 PSI 3/8" Female Ports
ORDER # 8001-598-8138 \$ 99.95

3.0 GPM - 45 PSI 1/2" Male Ports
ORDER # 2087-593-135 \$ 129.95

We also carry many other parts and accessories for your spraying needs. See pg 72-73. Give us a call for items not listed. 1-800-333-9143

WEED WIPERS

Weed wiping with sponges are the most effective and economical way to control taller growing weeds.

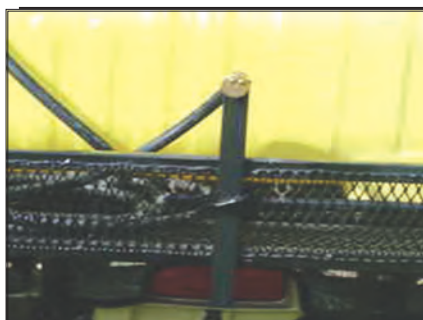

BOOMLESS NOZZLE

25 FT COVERAGE

Ideal for Spraying Areas where a Boom Is Not Feasible Fits Tubular or Wire Mesh Racks. Easy to Install. Comes with Mounting Hardware

ORDER # ATV-BN2..... \$49.95

REPLACEABLE GUNS

TEEJET SPOT SPRAYER GUNS

Constructed of molded polypropylene for Excellent Chemical Resistance & Durability. Rated 150 PSI- works with 3/8" ID hose.

Overall Length 32"
ORDER # 22670-PP..... \$ 36.95

Overall Length 23"
ORDER # 50800..... \$ 17.95



VALLEY GUNS

Rated to 300 PSI, 6 GPM. Spray tip adjusts from bullet spray to cone spray.

Overall Length 26"
ORDER # 5273959..... \$ 28.95



Other Guns, Parts & Accessories Available See Sprayer Section

Then the Lord said, "I give you every seed bearing plant on the face of the earth and every tree in it. They will be yours for food"..... And it was so.

— Genesis 1:29-30



Now Available in **Red**, **Green**, **Orange**

SPRING TINE COMBINATION GARDEN PACKAGE



*Garden Package with
Spring Tine Cultivators
Newly Designed Toolbar
Makes For More
Functionalty Which Makes
Gardening Even Easier*

GARDENING MADE EASY

Three Implements To Fit ONE Versatile Tool Bar
Ideal For Tractors (12-30 hp)

FEATURES:

- Simple:** This New Design was inspired by feed back from customers just like you. The Frame has 3 full length bars which makes for more adjustability. This can be done in minutes. Row Builders can be removed easily by loosing set screw.
- Toolbar:** Constructed of Heavy 2" square tubing, 48" wide and is 32" long. Includes Lift Pins. Specify Color
- Cultivator:** Six Adustable Spring Tine Shanks with 4", 6" and 8" sweeps. Simply Loosen Tine Holder, Move Into Position And Tighten. Tine Holders Included.
- Disc Hillers:** (Often called Row Builders), Pair Of 14" Garden Line Hillers with greaseable bushings. Includes shank holders and u-bolts.
- Middle Buster:** Often called the Potato Plow. Heavy duty 12" point designed for digging potatoes or simply using it to open a trench for water drainage. Sure beats a shovel.

ORDER # C2006GP

Weight 208 lb..... \$ 575.00

Must Ship Freight Truck



The Best Sermons Are Lived, Not Preached



Now Available in **Red, Green, Orange**

HEAVY DUTY SPRING TINE COMBINATION GARDEN PACKAGE

HEAVY DUTY SPRING TINE CULTIVATOR

HEAVY DUTY 15" MIDDLE BUSTER

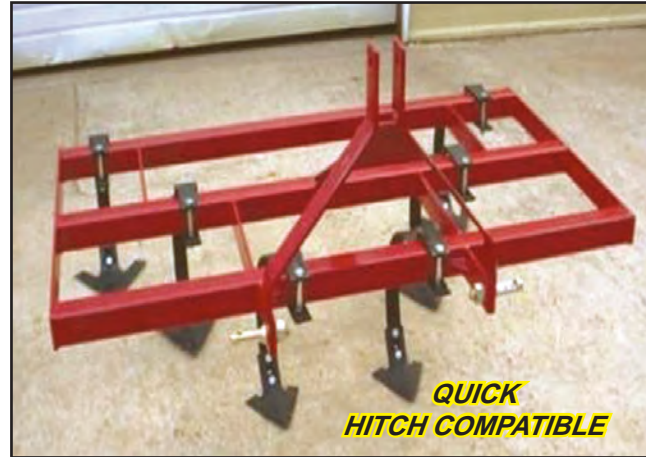
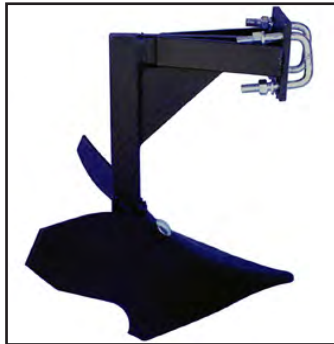

HEAVY DUTY 16" ROW BUILDERS



Includes all Items Pictured

ANOTHER GREAT ADDITION TO OUR GARDEN PACKAGE LINE
Ideal For Tractors 30 - 45

FEATURES:

- Simple:** This New Design was inspired by feed back from customers just like you. The Frame has 3 full length bars which makes for more adjustability. This can be done in minutes. Row Builders can be removed easily by loosing set screws.
- Toolbar:** 2-1/2" Heavy Duty Square Tubing. This Unit Is 60" Wide x 32" Long. Includes Lift Pins. Specify Color
- Cultivator:** 6 Fully Adjustable Spring Tine Shanks with 6", 8" and 10" sweeps. Simply Loosen Tine Holder, Move Into Position And Tighten. Tine Holders Included.
- Disc Hillers:** Often called Row Builders, are two 16" Heavy Duty Hillers with Sealed Bearings. Shanks are 1-1/4 x 22". Shank Holders Included.
- Middle Buster:** Often called the Potato Plow. Heavy duty 15" point. Designed for digging potatoes, breaking ground or digging a trench for water drainage.

ORDER # C2506GP

Weight 285 lb.....\$ 740.00

Must Ship Freight Truck



If you find yourself in a hole, the best thing to do is to stop digging

GARDENING IMPLEMENTS



Now Available in Red, Green, Orange COMBINATION GARDEN PACKAGE



- Build Rows*
- Cultivate Crop*
- (De-Weed)*
- Dig Potatoes*
- Lay By Crop — Pull Dirt To The Crop*



6 Shank Pictured



QUICK HITCH COMPATIBLE

New Style Bar For 2020

GARDENING MADE EASY

ADJUSTABLE - SIMPLE - FAST - EASY

Designed for small tractors 12 - 40 HP — Three Implements to fit ONE Versatile Tool Bar

FEATURES:

Simple:

It is not necessary to remove the shank holders, just loosen the set screws and insert the Disc Hillers or Plow Points. The shank holders can be left on the Toolbar. The Middle Buster or the Potato Plow is the only item that must be installed.

4 Shank Cultivator:

Constructed of Heavy 2" square tubing, 60" Long with Adjustable 1" x 16" solid stiff shanks, with 4" and 6" sweeps. Specify Color

6 Shank Cultivator:

Constructed of Heavy 2" square tubing, 60" Long with Adjustable 1" x 16" solid stiff shanks, with 4", 6" and 8" sweeps. Specify Color

Disc Hillers:

Often called Row Builders, are two 14" Garden Line Hillers with greaseable bushings. Includes 2 shank holders and u-bolts.

Middle Buster:

Often called the Potato Plow. Heavy duty 12" point designed for digging potatoes or simply using it to open a trench for water drainage. Sure beats a shovel.

TWO GARDEN PACKAGES AVAILABLE



4 Shank Package	Weight 150 Lbs.	ORDER # CGP4.....	\$ 585.00
6 Shank Package	Weight 180 Lbs.	ORDER # CGP6.....	\$ 685.00



Now Available in **Red**, **Green**, **Orange**

HEAVY DUTY COMBINATION GARDEN PACKAGE

Includes all Items Pictured

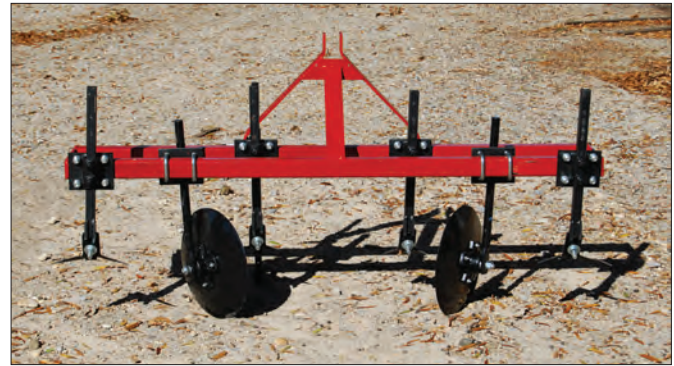
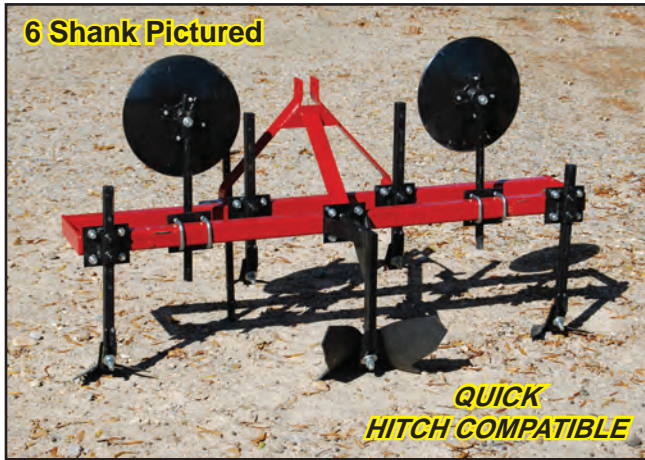

4 or 6 SHANK HEAVY DUTY CULTIVATOR

So Simple To Use

It is not necessary to remove the shank holders, just loosen the set screws and insert the Disc Hillers or Plow Points. The Middle Buster or the Potato Plow is the only item that must be removed and replaced.

FEATURES:

- Toolbar:** 2-1/2" x 72 Heavy Duty Square Tubing. Includes Lift Pins. Specify Color
- 4 Shank Cultivator:** Adjustable 1-1/4" x 20" solid stiff shanks, with 6" and 8" sweeps. 4 Heavy Duty Shank Holders. Specify Color
- 6 Shank Cultivator:** Adjustable 1-11/4" x 20" solid stiff shanks, with 6", 8" and 10" sweeps. 6 Heavy Duty Shank Holders. Specify Color
- Disc Hillers:** Often called Row Builders, are two 16" Heavy Duty Hillers with Sealed Bearings. Shanks are 1-1/4 x 22". Includes 2 Round Shank Holders with U-Bolts
- Middle Buster:** Often called the Potato Plow. Heavy duty 15" point. Designed for digging potatoes, breaking ground or digging a trench for water drainage. Sure beats a shovel.

Ideal For Tractors 30 - 50

Must Ship Freight Truck



TWO GARDEN PACKAGES AVAILABLE

4 Shank Package	Weight 275 Lbs.	ORDER # CGP4-HD.....	\$ 795.00
6 Shank Package	Weight 300 Lbs.	ORDER # CGP6-HD.....	\$ 895.00



Now Available in **Red, Green, Orange**

HEAVY DUTY ROW BUILDER

**QUICK
HITCH COMPATIBLE**



Ideal for large gardening and truck patch operations. Tractor HP Range 25-50. Consists of one 2-1/2" x 60" sq. Toolbar, two Mounting Clamps, Two heavy duty 16" Sealed Ball Bearing Disc Hillers with 1-1/4" x 22" Shank. **Can Ship Fed Ex.**

ORDER # CRBK16HD Weight 110 lb..... \$325.00

ROW BUILDER

**QUICK
HITCH COMPATIBLE**



Ideal For Compact Tractors 12-30 Hp. Build beautiful large rows in minutes. Pull Dirt to your Crops. Put the Hoe up! Kit Consists of one 2" x 2" x 60" Tool Bar, Two Mounting Clamps with U-Bolts, Two 14" Garden Line Disc Hillers With 14" Plain Blades. Build wide or narrow Rows - Fully Adjustable. **Can Ship Fed Ex.**

ORDER # CRBK14 (14" Hillers) Weight 70 lb.....\$ 285.00

TWO ROW - ROW BUILDER

**QUICK
HITCH COMPATIBLE**



Comes Complete With 80" Tool Bar, Shank Holders and Two Sets Of Row Builders

Standard (pictured)

14" Row Builders - 2" Bar
Order # CRBK142ROW Weight 130 lb..... \$415.00

Heavy Duty

16" Row Builders - 2-1/2" Bar
ORDER # CRBK16-HD2ROW Weight 176 lb..... \$490.00

ROW BUILDERS WITH SWEEP KIT

**QUICK
HITCH COMPATIBLE**



Same Features As Row Builders Above But Includes 2 Shank Holders, 2 Shanks, And 2 10" Sweeps

**ORDER # CRBK1410S Weight 105 lb.....\$ 375.00
With 10" Sweep Kit**

**ORDER # CRBK16-HD10S Weight 156 lb.....\$ 495.00
With 10" Sweep Kit (pictured)**

GARDEN LINE DISC HILLERS

Ideal for building or hipping up rows. Designed for small gardening. 14" Blades with Round Shanks 1-1/4" x 16". Greaseable bushings. For tool bar mounting see tool bar accessories. 14" Plain Blade. **Sold in Pairs**



ORDER # DH14P Weight 26 Lb.....\$ 95.00

HEAVY DUTY DISC HILLERS

Heavy Duty Sealed Ball Bearing - 16" Blades

Used in Truck Patch Operations and Large Gardening. Great for Building or Hipping Rows. Blade size 16", Round Shank 1-1/4" x 22". Priced Per Pair.



ORDER # DH31752 Weight 36 lb.....\$ 125.00



Now Available in **Red, Green, Orange**

GARDEN LINE ROW HIPPER

**QUICK
HITCH COMPATIBLE**



Ideal For Small Tractors 15-25 Hp in small gardening operations. Adjustable, Swivels, Tilts, Angles. Tool Bar 2" x 2" x 60" sq. Three 14" Notched Blades per side and greaseable bushings.

GREAT Row Builder! NOT Designed to Break New Ground.
ORDER # CLD05 Weight 107 lb \$ 430.00

DELUXE ROW HIPPER

**QUICK
HITCH COMPATIBLE**



Adjustable, Swivels, Tilts, Angles. 2-1/2" sq x 60" Tool Bar. Ideal for Tractor HP Range 25-45. Used in large gardening and truck patch operations. Three Heavy 16" Notched Blades Per Side. Heavy Cast Iron Greasable Bearings. NOT Designed to Break New Ground.

ORDER # DRH Weight 239 lb \$ 695.00

GANG ASSEMBLIES

FITS: 2" Tool Bar



CLD05 Gang Assembly with brackets, LESS Toolbar
Greasable Bushings Includes U-Bolts 14" Notched Blades
ORDER # CLD05GA Weight 92 lb..... \$ 325.00

FITS: 2-1/2" Tool Bar



DRH Gang Assembly with brackets, LESS Toolbar
Greasable Bearings Includes U-Bolts 16" Notched Blades
ORDER # DRHGA Weight 150 lb \$ 550.00

Trust in the LORD with all your heart and lean not on your own understanding; in all your ways submit to him, and he will make your paths straight. — Proverbs 3:5-6

CHECK OUT OUR NEW UNIVERSAL EQUIPMENT STAND ON PG. 23. MOUNTS TO LIFT PIN OR CAN BE WELDED IN ANY POSITION

ROW OPENER

Attaches to Row Builders Or Row Hippers To Open Row. Also A Nice Addition for the Garden Packages.

Great Time Saver

2" Toolbar - Uses 1" Shank
Weight 8 lb ORDER # CRO1620.....\$34.95
2-1/2" Toolbar-Uses 1-1/4" Shank
Weight 14 lb ORDER # CRO1725.....\$46.95



Row Opener Assembly



Includes: Row Opener, Shank, and Plow Point

2" Toolbar |
Uses 1" Shank
CRO1620-ASSY Wt. 16 lb
\$ 62.95

2-1/2" Toolbar |
Uses 1-1/4" Shank
CRO1725-ASSY Wt. 26 lb
\$ 87.95

Don't give the Devil a Ride, Because he'll want to drive



Now Available in **Red, Green, Orange**

COMPACT CULTIVATOR



Ideal for Compact Tractors 12-35 HP. Adjustable Stiff Shanks with Sweeps. Toolbar is 2" Square Double Bars 60" Wide, Shanks are 1" sq x 16".

FOUR SHANK CULTIVATOR

Two 2" Sq x 60 Bars with 2-4" and 2-6" sweeps.
ORDER # CLD124 Weight 85 lb..... \$ 380.00

SIX SHANK CULTIVATOR:

Two 2" Sq x 60" Bars with 2-4", 2-6" and 2-8" sweeps.
ORDER # CLD126 Weight 100 lb..... \$ 495.00

**A Variety Of Attachments Are Available.
 See Tool Bar Accessories Pgs 22-23**

ONE ROW CULTIVATOR



One Row Cultivator With 6 Heavy Duty Spring Heat Treated Tines with Sweeps. Fully Adjustable, Just Loosen Bolt and Slide Tine Where Needed. Width 48", built of heavy wall 2" sq. tubing. Sweeps include 2-4", 2-6" and 2-8".

ORDER # C2006 Weight 150 lb..... \$ 370.00

OPTIONAL ACCESSORIES

14" Garden Line Hillers-Pair
ORDER # DH14P \$ 95.00
 Disc Hiller Brackets-Each | **ORDER # RSH \$ 29.95**

He that walketh with the wise men shall be wise; but a companion of fools shall be destroyed. — Proverbs 13:20

HEAVY CULTIVATOR



FITS: Cat 1 Tractors. Toolbar is 2-1/2" x 72" Heavy Tubing with Lift Pins. Tractor HP Range 25 - 40.

FOUR SHANK CULTIVATOR

Four 1-1/4" Sq X 20" Adjustable Shanks with 2-6" and 2-8" sweeps. Tractor HP Range 25 - 40.

ORDER # HDC4 Weight 170 lb \$ 540.00

SIX SHANK CULTIVATOR

Six 1-1/4" Sq X 20" Adjustable Shanks with 2-6", 2-8" and 2-10" sweeps. Tractor HP Range 25 - 40.

ORDER # HDC6 Weight 210 lb \$ 695.00

**A Variety Of Attachments Are Available.
 See Tool Bar Accessories Pgs 22-23**

DELUXE ONE ROW CULTIVATOR



One Row Cultivator With 6 Heavy Duty Spring Heat Treated Tines with Sweeps. Fully Adjustable, Just Loosen Bolt and Slide Tine Where Needed. Width 58", built of heavy wall 2-1/2" sq. tubing. Sweeps include 2-6", 2-8" and 2-10".

ORDER # C2506 Weight 175 lb..... \$ 450.00

A Variety Of Attachments Available. See Tool Bar Accessories For 2 1/2" Square Tool Bar. Pgs 22-23

All Tool Bars Are QUICK HITCH COMPATIBLE



DELUXE EXTRA WIDE CULTIVATOR



Heavy Tubular Iron Construction: 2" x 2" x 80". 10 Extra Heavy Duty Heat Treated Tines, 7/16" thick x 2" wide. 5 Tines on the Front, 5 on the Rear. Simple & Easy To Adjust to any Position. Category 1. 3 Point Hitch.

ORDER # G-CTR10 Weight 170 lb \$ 475.00

CULTIVATOR ATTACHMENT

Designed for close cultivating. Three heavy duty spring tines per side, with 10" reversible spring points. Mounted on heavy angle iron with 1-1/4" round shank. For Toolbar mounting see Toolbar Accessories. Priced per pair.



ORDER # STA Weight 60 lb..... \$ 195.00

BREAKING PLOWS

Heavy Duty — Shear Bolt Protected



Stand Not Included



1 Bottom 14" Tractor HP Range 25-40
ORDER # G-1BMP14 Weight 273 lb \$ 575.00

2 Bottom 14" Tractor HP Range 30-50
ORDER # G-2BMP14 Weight 490 lb \$ 975.00



CHECK OUT OUR NEW UNIVERSAL EQUIPMENT STAND ON PG. 23. MOUNTS TO LIFT PIN OR CAN BE WELDED IN ANY POSITION

MIDDLE BUSTERS

Applications:

Layoff Rows | Opening Furrows | Digging Potatoes
Opening a Ditch for a water line or drainage

12" BUSTER POINT

Designed for Tractors
12-18 HP

ORDER # MMB100
Weight 55 Lb
\$ 155.00



15" BUSTER POINT

Designed for Tractors
20-35 HP

ORDER # MB100
Weight 80 lb
\$ 165.00



15" HEAVY DUTY BUSTER

Designed for Tractors
20-45 HP

FEATURES: 2-1/2" X 26"
Square Toolbar, 15" Buster Point,
Heavy Duty Shank.

ORDER # MB100-HD
Weight 100 lb
\$ 245.00



TWO ROW MIDDLE BUSTER



Two Heavy Duty 15" Busters on a 60" x 2-1/2"
Square Toolbar.
ORDER # MB200 Weight 190 lb..... \$ 390.00

All Tool Bars Are
QUICK HITCH COMPATIBLE

TOOLBARS



Now Available in **Red, Green, Orange**

SINGLE TOOLBARS

Our Toolbars are Cat. 1 Quick Hitch Compatible Industry Standard 26-1/2" .

Complete with Cat. 1 Pins.

All Welded 3/16 Tubular Construction

****SQ Denotes Square Bar / DS Denotes Diamond Bar****

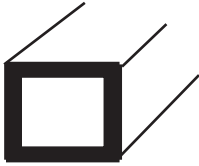

Square Bar = SQ
View From Side



Diamond Bar = DS
View From Side



SQUARE BARS

ORDER #	SIZE	WT.	PRICE
TB60SQ	2" X 2" X 60"	38	\$117.00
TB6025SQ	2-1/2" x 2-1/2" x 60"	53	\$135.00
TB2625SQ	2-1/2" x 2-1/2" x 26"	30	\$110.00
TB80SQ	2" X 2" X 80"	54	\$134.00
TB8025SQ	2-1/2" x 2-1/2" x 80"	70	\$155.00

DIAMOND BARS

ORDER #	SIZE	WT.	PRICE
TB60DS	2" x 2" x 60"	38	\$127.00
TB6025DS	2-1/2" x 2-1/2" x 60"	53	\$145.00
TB8025DS	2-1/2" x 2-1/2" x 80"	70	\$165.00

See Our Toolbar Attachment Page
For Attachment Options



3715 Hwy 71 • Coushatta, LA 71019
1-800-333-9143
Fax: 318-932-9800

We offer **FREE CATALOGS** on tractor parts, small farm equipment & deer feeders with ATV accessories. Call the toll-free number above or mail/fax in the form at the back of this catalog.

CULTIVATOR BARS

High Quality USA MADE Toolbars - Quick Hitch Compatible

TRIPLE CULTIVATOR TOOLBARS

CULTIVATOR BAR - 3 BAR Design
Includes Lift Pins

2" TRIPLE SQUARE BAR
48" WIDE X 30" DEPTH
Wt. 92lb
ORDER # C2006-F.....\$ **228.00**

2-1/2" TRIPLE SQUARE BAR
60" WIDE X 32" DEPTH
Wt. 136lb
ORDER # C2506-F.....\$ **267.00**



See Our Toolbar Attachment Page
For Attachment Options

DOUBLE CULTIVATOR TOOLBARS

CULTIVATOR BAR - 2 BAR Design
Includes Lift Pins

2" DOUBLE SQUARE BAR
60" WIDE X 10" DEPTH
Wt. 66 lb
ORDER # TBLD126\$ **160.00**

80" WIDE X 16" DEPTH
2" SQUARE BAR
Wt. 82 lb
ORDER # G-CTR10-F\$ **235.00**

HEAVY DUTY 2-1/2" DOUBLE SQUARE BAR
72" WIDE X 12" DEPTH
2-1/2" SQUARE BAR
Wt. 100 lb
ORDER # TBHDC4\$ **198.00**

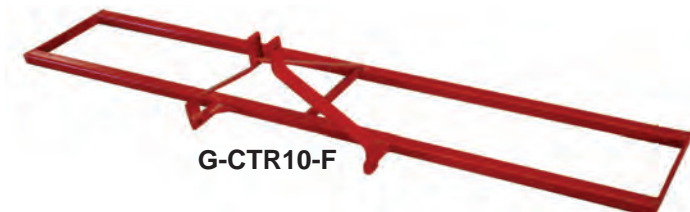

G-CTR10-F



TBLD126

New For 2020

See Our Toolbar Attachment Page
For Attachment Options

Universal 2" Receiver Mount

Simply Mounts To Your Existing Toolbar
Used for Moving Trailers and Implements
Without Having To Remove Your Toolbar
Great Addition To Your Equipment
U-Bolts Included



New For 2020

For 2" & 2-1/2" Toolbars

2" Bar Wt. 8.4
Order # TBRH20..... \$ **29.95**

2-1/2 Bar Wt. 8.8
Order # TBRH25..... \$ **32.95**



All our Attachments And Toolbars Are Proudly Built Here In The USA

FITS: 2-1/2" Square Bars



Shank Holder: Accepts a 1-1/4" Sq. Or Round Shank.
Fit 2-1/2" Toolbars. Includes U-bolts
Also accepts 1-3/8" Round Shank
Wt. 8 # SH25 \$36.95

FITS: 2" Square Bars



Round Shank Holder with U-Bolts
Fits 2" Toolbar
Accepts a 1-1/4" Round Shank
Wt. 5 # RSH \$29.95

FITS: 2-1/2" Square Bars

NEW for 2020



Round Shank Holder with U-Bolts
Fit 2-1/2" Toolbar
Accepts a 1-1/4" Round Shank
Wt. 5 # RSH250 ... \$32.95

FITS: 2" Square



Square Shank Holder with U- Bolts
Fits 2" Toolbar
Accepts a 1" Square Shank
Wt. 5 # SSH..... \$29.95

FITS: Flat or Angle Iron Frame



Shank Holders: Accepts 1-1/4" Rd or 1" Sq Shank. Sold in Pairs
Mounts To Any Flat or Angle Iron Bar
Includes Mounting Bolts
Wt. 7 # STHC \$41.95

FITS: 2" & 2-1/2" Diamond



Fits 2" or 2-1/2" Diamond Bar Clamp: Heavy Duty accepts a 1-1/4" or 1-3/8" Round or Square Shank.
Wt. 13 # DC1312 \$43.95

Plow Shanks



Square Shank - Solid 1" x 16", used for Mounting Sweeps
Wt. 8 # SS100 \$27.95



Round Shank: Solid 1-1/4" Rd. x 20" Used for Mounting Sweeps
Wt. 8 # RS20 \$32.95



Square Shank: Solid 1-1/4" Sq. x 20" Used for Mounting Sweeps
FITS: All 1-1/4 Square Shanks
Wt. 10 # SS125 \$37.95

SPRING TINE BRACKET

Mounts Spring Tine To Your 2" or 2-1/2" Toolbar. Includes Mounting Bolt

FITS: 2" Toolbar

Wt. 1.36 # TH200 \$9.95

FITS: 2-1/2" Toolbar

Wt. 1.52 #TH250 \$9.95

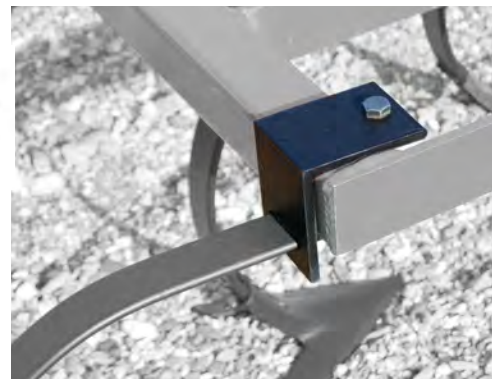

See Page 77 for Tines and Sweeps

FITS: Square Or Diamond Bar



Middle Buster: Heavy Duty with 15 Buster Point with U-Bolts



2-1/2 Square Bar
Wt. 60 # MBS25SQ.....**\$130.00**



2-1/2 Diamond Bar
Wt. 60 # MBS25DS.....**\$140.00**



Mini Middle Buster
with 12" Heavy Duty Point with U-Bolt

Wt. 22 # MMBS.....**\$ 85.00**

ROW OPENER

Attaches to Row Builders Or Row Hippers To Open Row. Also A Nice Addition for the Garden Packages.

!Great Time Saver!

2" Toolbar | Uses 1" Shank
Wt. 8 # CRO1620.....**\$34.95**



2-1/2" Toolbar
Uses 1-1/4" Shank
Wt. 14 # CRO1725.....**\$46.95**

ROW OPENER ASSEMBLY

Includes: Row Opener, Shank, and Plow Point

2" Toolbar |
Uses 1" Shank
CRO1620-ASSY
Wt. 16.....**\$ 62.95**



2-1/2" Toolbar |
Uses 1-1/4" Shank
CRO1725-ASSY
Wt. 26.....**\$ 87.95**

"I am the vine; you are the branches. If a man remains in me and I in him, he will bear much fruit; apart from me you can do nothing."

— John 15:5 NIV

NEW for 2020

Universal Equipment Stand

Allows Equipment to Remain Standing for Easy Hook Up.

Designed to Mount to the Lift Pin On Nut Side. Out of the Way. Mounting Options Vary. Facing forward or Backwards. Can also be welded to the A-Frame or Frame of the Equipment. Very Versatile. Adjust to Different Heights. Stand Pipe 30"

ORDER # M-EQS.....\$26.95



HEAVY DUTY TILLERS

Six Tines Per Rotor & Slip Clutch



Heavy Duty 3 pt. Hitch - Clevis Style for Easy Hook Up
Six Heavy Heat Treated Tines Per Rotor | 7" Deep Adjustable Skid Shoes

- 48" Width For Tractors 25 -35 HP
ORDER # G-FTL48G **Wt. 335 lb \$ 1595.00**
- 60" Width For Tractors 25 - 48 HP
ORDER # G-FTL60G **Wt. 360 lb \$ 1795.00**
- 65" Width For Tractors 30 - 50 HP
ORDER # G-FTM65G **Wt. 646 lb..... \$ 1995.00**
- 72" Width For Tractors 42 - 60 HP
ORDER # G-FTM72G **Wt. 679 lb..... \$ 2095.00**

Many Other Models and Sizes Available To Suite Your Needs
Give Us A Call at 1-800-333-9143!

GARDEN LINE DISC

IDEAL FOR GARDENING - Low Profile



Angle Iron Construction
16" Notched Blades | Greasable Teflon Bushings
Pre-set Blade Angle | Low Profile Design

- 4 ft. Tandem:** With 12-16" blades.
Tractor HP range 20-35 .
Teflon Bushings | Wt. 334 lb | # DH-WF4.....\$ 625.00
- 5 ft. Tandem:** With 16-16" blades.
Tractor HP range 25-45.
Teflon Bushings | Wt. 422 lb | # DH-WF5.....\$ 695.00

Shipped Assembled by Truck

But as for me and my house, we will serve the Lord. — Joshua 24:15b

GARDEN LINE DISC

4 ft. Single
Has 6-16" Notched Blades.
For Tractors 12-18 HP
ORDER # 616C
Wt. 185 lb.....\$ 550.00



TANDEM DISC HARROWS

FEATURES:

Heavy Duty Frame | Notched Blades
Threaded Adjustable Gangs
1" Square Axles

Heavy Duty

- 400 Series**
5-1/2 Ft. Width 16 - 18" Blades, Sealed Bearings
ORDER # DH-1618SB | Weight 650 lb.....\$ 1250.00
- 500 Series**
6-1/2 Ft. Width 20 - 20" Blades, Sealed Bearings,
ORDER # DH-2020SB | Weight 1000 lb.....\$ 1825.00
- 7-1/2 Ft. Width** 24 - 20" Blades, Sealed Bearings,
ORDER # DH-2420SB | Weight 1100 lb.....\$ 2025.00



Commit to the LORD whatever you do, and your plans will succeed.
— Proverbs 16:3

COVINGTON PLANTER



\$1475.00

Plants & Fertilizes in one trip operation.

Comes with a variety of seed plates, (corn, beans, peanut, peas etc), as well as a 6T, 10T, 12T sprockets. Features a vibrator fertilize distributor, adjustable presser wheel for varying depth of your fertilize and seed. Seed spacing is varied by changing sprockets. Comes Assembled

ORDER # G-TP46 Weight 190 lb..... \$ 1475.00

**Also Available
In 2 Row Model
Includes Cultivator**



ORDER # G-TP462R9 Weight 755 lb..... \$ 3495.00

12MX PLANTER



Adjustable Width

FEATURES:

- Plants and Fertilizes on One Trip Operation.
- Set Seed Depth with Handle
- Adjustable Fertilizer Rate
- Includes 3 Planter Plates - Corn, Beans and Peas
- Includes 4 Gears for Seed Spacing
- Seed Opener is Independent of Presser Wheel, so you can get even, Consistent Planting even in Rough Terrain.

Ideal For The Small Farmer, Yet Flexible Enough For Large Truck Patch Operations. Heavy Duty 3 Pt Hitch. Additional Planter Plates Available.

Includes Toolbar

One Row
ORDER # G-12MX Weight 161 lb \$ 1050.00
Two Row
ORDER # G-12MX2R Weight 370 lb \$ 2295.00

COVINGTON, 12MX and COLE PLANTER PARTS AND SEED PLATES AVAILABLE:

SEE TILLAGE SECTION PAGES 80-83

COVINGTON SIDEDRESSER

Can Be Used As A One or Two Row

Special Vibrator Pan busts up lumpy fertilizer. Fertilizer boxes are adjustable. Simple - Quick - Easy, simply loosen two set screws and slide to desired position. Frame is Heavy Wall Square Tubing 2" x 2" x 80". Shown with Wood Fertilizer Boxes (most popular). Items are sold separate.

Description	Order #	Weight	Price
Side Dresser (Each)	G-TP3A	79 lb	\$ 490.00
Frame Only w/2 Brackets	G-TP3AF	165 lb	\$ 266.00

Complete Unit With Frame and One G-TP3A. Includes Mounting Brackets

Order # G-TP3AWF.....Wt. 250lb.....\$ 720.00



ROLLING CULTIVATOR & GANGS

ROLLING CULTIVATORS

Great Way to Get Rid Off Those Pesty Weeds In The Garden and Gives Soil Good Aeration.
Width And Angles Adjustable

Double Unit

Comes complete with 80" x 2" Double Tool Bar and 2 pair of 14" Spider Gang Cultivators

ORDER # CRC80414 Wt. 300 lb.....\$ 995.00

Single Unit

Comes complete with 60" x 2" Single Tool Bar and 1 pair of 14" Spider Gang Cultivators

ORDER # CRC60414 Wt. 180 lb.....\$ 499.00



Must Ship freight Truck

*Bear one another's burdens, and so fulfill the law of Christ.
For if anyone thinks himself to be something, when he is nothing, he deceives himself.
— Galatiaans 6:2-3*

ROLLING CULTIVATOR GANGS

Great Way to Get Rid Off Those Pesty Weeds In The Garden and Gives Soil Good Aeration.

14" Spider Gang Cultivators

Sold Individually. You must Order LH and RH for pair.
Tops are slotted for a variety of mounting options.

ORDER #	SIDE	WEIGHT	PRICE
# 49441	LH	66 lb	\$139.95
# 49442	RH	66 lb	\$139.95



Sold Individually

Mounting Options

Top Plate Only

ORDER #	WEIGHT	PRICE
# RCMP	66 lb	\$24.95

Complete Assembly - Sold Individually

ORDER #	WEIGHT	PRICE
2" BAR		
# RCMB200ASSY	14 lb	\$ 49.95
2-1/2" BAR		
# RCMB250ASSY	20 lb	\$ 64.95



Sold Individually

MEDIUM OR HEAVY DUTY

NEW HEAVIER DIGGERS

FEATURES:

- Standard 2" Output Shaft
- Catagory 1 Pins
- Drive Line Shear Bolt Protected

****AUGERS SOLD SEPARATELY****

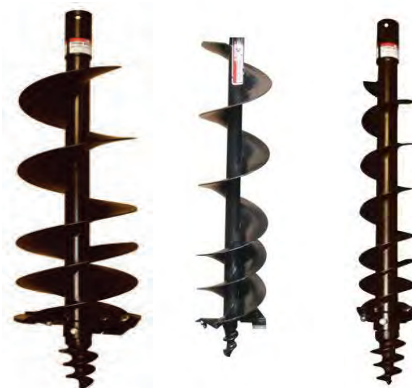

Two Models Available

Medium Duty

Great for Medium Duty Work,
You can use up to a 12" Auger.

ORDER # M-PHD-AG

Weight 200 lb **\$ 575.00**

Heavy Duty

Great for Heavier Work,
You can use up to a 24" Auger.

ORDER # M-PHD-SPHD

Weight 235 lb **\$ 730.00**

Augers Available

ORDER #	SIZE	WEIGHT	PRICE
M-PHA-AG6	6"	30	\$ 120.00
M-PHA-AG9	9"	35	\$ 135.00
M-PHA-AG12	12"	50	\$ 170.00
M-PHA-SP18	18"	99	\$ 260.00
M-PHA-SP24	24"	125	\$ 495.00

See Page 84 For Post Hole Digger Blades and Tips.

**WE ALSO CARRY
RELACEMENT
BLADES AND
POINTS FOR MANY
STYLES OF POST
HOLE AUGERS AND
REPLACEMENT
GEARBOXES FOR
YOUR DIGGERS.**

**SUBSOILER POINTS
AND BUSTER
BLADES ARE ALSO
AVAILABLE. JUST
GIVE US A CALL.**

SUBSOILER OR TRENCHER

FEATURES:

- Catagory 1, 7/8" Pins.
- Reversible & Replaceable
2" x 6" Heat Treated Point.
- Shank is 3/4" X 6" X 17" Usable Length.
Overall Height 32".
- Shear bolt Protected.
- 20 HP Minimum Tractor Rating.
- Can Ship FedEx.



ORDER # M-SS1

Weight 168 lb **\$250.00**

Whoever drinks off the water I shall give him will never thirst. But the water that I give him will become a fountain of water springing up into everlasting life.
— John 4:14

BOX BLADES / GRADER BLADES

STANDARD DUTY BOX BLADES

All With Adjustable Shanks And Replaceable Front and Rear Scraper Blade

Tractors 20 to 40 Hp

Size	Weight	Order #	Price
48"	247	#D-BBSB48	\$ 425.00
60"	375	#D-BBSB60	\$ 545.00
72"	400	#D-BBSB72	\$ 650.00



HEAVY DUTY BOX BLADES

All With Adjustable Shankes And Clevis Hitch Hook Up. Replacable Front and Rear Scraper Blade

Tractors 20 to 40 Hp

Size	Weight	Order #	Price
48"	405	#D-BBHD48	\$ 500.00
60"	455	#D-BBHD60	\$ 595.00

Tractors 35 to 75 Hp

Size	Weight	Order #	Price
72"	515	#D-BBHD72	\$ 745.00
84"	617	#D-BBHD84	\$ 875.00
96"	657	#D-BBHD96	\$ 995.00



ECONOMY GRADER BLADES

Economical for Smaller Tractors and UTV/ATV Applications



- All Models Swivel 360 Degrees.
- Tilt, Angle, and Offset By Simply Loosening Two Nuts On Rear of Blade.
- Scraper Blade Is Replaceable

Size	Weight	Order #	Price
4 ft	105	#D-GB4	\$ 425.00
5 ft	240	#D-GB5	\$ 450.00
6 ft	270	#D-GB6	\$ 465.00

Feeling appreciated is one of the most important needs that people have. When you share with someone your appreciation and gratitude, they will not forget you.

MEDIUM DUTY OFFSET GRADER BLADES



5', 6', and 7" Models - 5 Forward and 5 Reverse Angle Positions - Pan-Tilt Adjustment for Ditching - Manual Offsets - Moldboard Height 15 1/2" Cat I - Reversible Cutting Edge

Size	Weight	Order #	Price
60"	338	# D-GB6-OSK	\$ 650.00
72"	348	# D-GB7-OSK	\$ 699.00
84"		# D-GB8-OSK	\$ 799.00

HEAVY DUTY OFFSET GRADER BLADES



6', 7' and 8' Models - Pan-Tilt Adjustment for Ditching - Manual Offsets Included (Hydraulics Optional) - Moldboard Height 17 1/2" Cat I or II Hitch

Size	Weight	Order #	Price
72"	439	# D-GB72HDK	\$ 925.00
84"	469	# D-GB84HDK	\$ 999.00
96"	503	# D-GB96HDK	\$ 1125.00

However, as it is written: "No eye has seen, no ear has heard, no mind has conceived what God has prepared for those who love Him." — 1 Corinthians 2:9

HEAVY DUTY SOIL MOVER

Available in 5 Ft, 7 Ft & 10 Ft

Heavy Duty Industrial Quality Works Like A Motor Grader Ideal For Leveling Roads & Driveways



MODEL #	SIZE	WEIGHT	TRACTOR HP	PRICE
D-DG-05	5 Ft	825	25 Up	\$ 1375.00
D-DG-07	7 FT	950	35 Up	\$ 1475.00
D-DG-10*	10 Ft	1380	65 Up	\$ 1895.00

* Special Order

LIGHTER DUTY SOIL MOVERS

Built As Tough

But On The Economical Side

MODEL	SIZE	WEIGHT	PRICE
D-DGLSMA5	5Ft	425	\$ 835.00
D-DGLSMA6	6Ft	450	\$ 999.00
D-DGLSMA7	7Ft	550	\$ 1175.00



IF YOU ARE WILLING AND OBEDIENT, YOU SHALL EAT THE GOOD OF THE LAND.

— ISAIAH 1:19



CULTIPACKER



GREAT FOR SMOOTHING OF PLOWED LAND AND ALSO ASSIST IN RETAINING SOIL MOISTURE!

Our Newly Added Cultipackers Makes A Great Addition to Your Pasture Equipment

FEATURES:

- Heavy Duty Three Point Hitch And Channel Iron Frame
 - 2" Solid Shaft
- Greaseable Heavy Duty Pillow Block Bearings
 - 15" Cultipacker Wheels
 - 30" Adjustable Stand

Comes In THREE Sizes

6 Ft. - ORDER # M-CP72S
Weight 644.....**\$ 1499.00**

8 Ft. - ORDER # M-CP96S
Weight 832.....**\$ 1740.00**

10 FT. Available By Special Order. Give Us A Call

SPIKE TOOTH HARROWS

3 Point Hitch



Ideal For Dragging Pastures, Leveling Plowed Ground. Carbon Steel Teeth 3/4" Welded. Heavy Duty 3 Pt. Hitch Category 1 with Flexible Feature, allowing Harrow to float over Uneven Terrain smoothly and easily. Wing Section Available in Pairs Only.

ORDER #	Size	Weight	PRICE
M-STH 5	5 Ft.	275	\$ 720.00
M-STH 7	7 Ft.	350	\$ 740.00
M-STH10	10 Ft.	400	\$ 925.00

**CHAIN LINK HARROWS
HEAVY DUTY**

Ideal For Dragging Pastures, breaking up clods, preparing food plots, covering up seed, scratching ground for rye grass, etc. Teeth features a Flip-Over Design that allows aggressive or light harrowing. These models are the heaviest on the market.



Made with 5/8" 1060 Steel

Pull with an ATV - Jeep - Truck - Tractor

ORDER #	Size	Weight	PRICE
M-BO5	4 Ft-4"	165	\$ 695.00
M-BO7	6 Ft-6"	230	\$ 995.00
M-BO9	8 Ft-8"	300	\$ 1150.00
M-BO11	10 Ft-10"	360	\$ 1395.00
M-BO13	13 Ft	430	\$ 1595.00

All Harrows Are 8 Ft Long

PASTURE RENOVATOR



Ideal For Small to Medium Acreage. Works Great In Most Soils. Category 1 Hitch. Maximum Hp Rating 50 HP. Features Three Heat Tempered Shanks. Shanks are Designed for Minimal Soil Disturbance. Shear Bolt Protected, Shanks are Spaced 17" on Center. Toolbar Construction is 3" Heavy Square Tubing X 48" Long. Slices through soils easily. Primarily used for aerating pastures, other uses include Raking Roots, Ripping Hard Ground.

ORDER # PR3 Weight 125 Lb. \$ 250.00

CHAIN LINK HARROWS



APPLICATION:

- Leveling:** Race tracks, playing fields, ant nests, gopher mounds, trail rides, spreading manure, etc.
- Seed Beds:** Food plots, harrowing the seed in the soil.
- Grass Stimulator:** Revitalizes the grass, allowing the moisture and air to reach the roots.

Made with 1/2 Steel

Pull with an ATV - Jeep - Truck - Tractor

Size	Weight	ORDER #	PRICE
48" (4x8)	150 lb	# M-FCH48	\$ 395.00
72" (6x8)	225 lb	# M-FCH72	\$ 650.00

PALLET FORK

FITS: Front End Loaders and 3 Point Hitch



Quick Hitch Attachments are Available

Head Guard Provides Safer Handling of Material. Rated at 2500 Lb. Capacity. Tines are Heavy 4" Channel Reinforced with Heavy Angle Iron on Underneath Side. Tines are Adjustable from 10" to 50", Tines are 40" Long. Pin Holes are 1".

ORDER # PF2500 Weight 355 Lb..... \$ 680.00

Skid Steer Quick Attach

ORDER # PF2500-QA Weight 370 Lb. \$ 795.00

****Other Quick Hitch Attachments Available. Call For Application.****

UTILITY CRANES/BOOMPOLES

LIFT Logs - Barrels - Cross Ties - Small Equipment

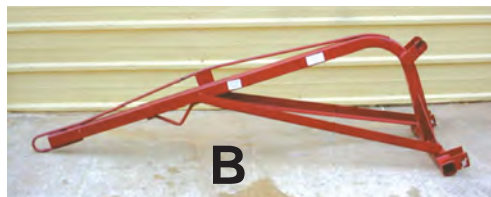
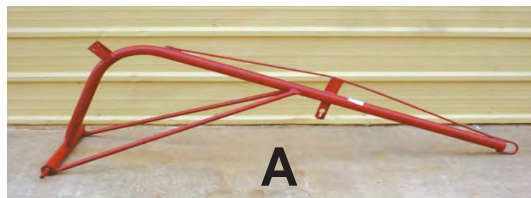

(Ref A) **Standard Duty** - Has A Lift Capacity Of 1200 Lbs. Constructed Of 2" Pipe. Ideal For Tractors 25-45 HP.
ORDER # M-BP1200 Weight 60 Lb \$ 190.00

(Ref B) **Heavy Duty** - Has A Lift Capacity Of 3000 Lbs. Constructed Of Heavy Square Tubing. Ideal For Tractors 50 HP & Up.
ORDER # BP3000 Weight 95 Lb \$ 295.00

CLAMP ON BUCKET FORKS

4000 lb Lifting Capacity

Clamps on to any style bucket. Forks are 4" wide x 43" usable length. Heavy Duty Fasteners. Chain holes for Optional Chain Fasteners allow for heavy Lifting. Other Lighter or Heavier Models Available



Installs in Minutes.

ORDER # PF4000-CLAMPON....Weight 102 lb....\$ 249.95

HANDY CARRY ALL

Ideal Applications

- Hauling Small Loads
- Fence Building
- Gardening
- Landscaping
- Moving Parts



Constructed of heavy angle iron. Flooring is heavy # 9 Expanded metal-No Rotting. Color bright red. Size is 47" x 46". Comes With Cat. 1 Pins.

ORDER # HCA Weight 180 lb \$ 295.00

Blessed is the one who does not walk in step with the wicked or stand in the way that sinners take or sit in the company of mockers, but whose delight is in the law of the LORD, and who meditates on his law day and night. That person is like a tree planted by streams of water, which yields its fruit in season and whose leaf does not wither— whatever they do prospers.

— Psalm 1:1-3

**Success Is
Getting up just one more time when you fall**

**Insanity Is
Continuing to do the same things
Yet expecting different results**

**Our annual church meeting was rather like heaven.
Many we expected to see there were absent**

KODIAK STANDARD DUTY

FEATURES:

- Gearbox - 40 HP. **5 year warranty**
- Top Link - Floating
- Stump Jumper – Pan Style
- Deck Thickness- 11 GA Steel
- Sides Bands - Heavy Duty 7" Channel.
- Wheels - Laminated, With Greasable Hubs
- Cutting capacity - 2"
- Slip Clutch - Optional
- Driveline - Series 4

Front & Rear Chain Guards are available

SIZE	WEIGHT	ORDER #	PRICE
4 FT	436	RC-EC48K	\$ 1250.00
5 FT	510	RC-EC60K	\$ 1295.00
6 FT	645	RC-EC72K	\$ 1545.00



Chain Guards Optional - Not Included

KODIAK MEDIUM DUTY

FEATURES:

- Gearbox- 90 HP. **5 year warranty**
- Top Link - Floating
- Stump Jumper – Solid Round- 5/8" Solid
- Deck Thickness- 11 GA Steel
- Sides Bands - Heavy Duty 7" Channel.
- Wheels - Laminated, With Greasable Hubs
- Cutting capacity - 2"
- Slip Clutch - Optional
- Driveline - Series 4

Front & Rear Chain Guards are available

SIZE	WEIGHT	ORDER #	PRICE
5 FT	615	RC-MD60K	\$ 1550.00
6 FT	755	RC-MD72K	\$ 1750.00



Chain Guards Optional - Not Included

KODIAK HEAVY DUTY

FEATURES:

- Top Link - Floating
- Gearbox- 90 HP. **5 year warranty**
- Slip Clutch- Standard
- Stump Jumper – Round- 5/8" Solid
- Deck Thickness- 3/16 or 7 GA Steel
- Sides Bands - Heavy Duty 8" Channel.
- Wheels - Laminated Dual Wheels (Single On 5 ft)
With Bearing Hubs
- Cutting capacity - 2"
- Heavy drivelines.

Front & Rear Chain Guards are available

SIZE	WEIGHT	ORDER #	PRICE
6 FT	1205	RC-HD72K	\$ 2495.00
7 FT	1375	RC-HD84K	\$ 2795.00



Chain Guards Optional - Not Included

KODIAK HEAVY DUTY 8 FT

FEATURES:

- Gearboxes -100 Hp center / 90 Outboard Hp
- **5 year warranty**
- Top Link - Floating
- Stump Jumper – 5/8" Thick Solid Round
- Deck Thickness- 10 GA Steel
- Sides Bands - Heavy Duty 7" Channel.
- Wheels - Laminated Dual Wheel With Bearing Hubs
- Cutting capacity - 2"
- Driveline - Series 5 With Thick Slip Clutch.
- Center Shafts Shock Coupler Protected
- Minimum Hp Required -38 Hp

Front & Rear Chain Guards are available



Chain Guards Optional - Not Included

Pull Type

SIZE	WEIGHT	ORDER #	PRICE
8 FT	1125	RC-HD96K	\$ 3595.00
8 FT	1225	RC-HDPT96K	\$ 5295.00

KODIAK HEAVY DUTY 10 FT

FEATURES:

- Gearboxes -100 Hp center / 90 Outboard Hp
- **5 year warranty**
- Top Link - Floating
- Stump Jumper – 5/8" Thick Solid Round
- Deck Thickness- 3/16 or 7 Gauge
- Sides Bands - Heavy Duty 8" Channel.
- Wheels - Laminated Dual Wheels With Bearing Hubs
- Cutting capacity - 2"
- Driveline - Series 5 With Slip Clutch.
- Center Shafts Shock Coupler Protected
- Minimum Hp Required -52

Front & Rear Chain Guards are available



Chain Guards Optional - Not Included

Pull Type

SIZE	WEIGHT	ORDER #	PRICE
10 FT	1470	RC-HD120K	\$ 4295.95
10 FT	1780	RC-HDPT120K	\$ 5795.00

FARM MAX GROOMING MOWER



FEATURES of the Heavy Duty Rear Discharge Mower

- Floating Clevis Hitch - makes 3 point Hook Up Simple, Quick & Easy. Allows the mower to follow Uneven Terrain
- Tires - Four Large Heavy Solid Tires - Prevents Scalping
- Deck - Heavy 8 Gauge thick Steel
- Blades - 3 Heavy Duty Hi-Lift Blades - Overlapping
- Easy Access Shields - Provides Easy Maintenance
- Cutting Height 1" to 4"
- Paint - Powder Coated Finish

ORDER #	SIZE	WEIGHT	PRICE
FM-FC48	48"	410	\$ 1795.00
FM-FC60	60"	450	\$ 1895.00
FM-FC72	72"	490	\$ 1995.00
FM-FC84	84"	860	\$ 2295.00

DELUXE SPREADER

500 & 700 Pound Capacity



FEATURES:

- **Catagory 1 Pins - No Sharp Edges**
- **Heavy Duty Hopper**
- **Low Maintenance**
- **Stainless Steel Spreader**
*Spreads 15'-55' Depending on Material.
 May Position For Right, Left, and Center Spreading.
 For Tractors 20HP and Up. No Assembly Required.*

ORDER # M-XA300 (500 lb Capacity)
 Wt. 145 lb..... **\$ 545.00**
 ORDER # M-XA500 (700 lb Capacity)
 Wt. 155 lb..... **\$ 645.00**
Also Available With Poly Hopper. Give Us A Call

Parts for Model M-XA300 Three Point Hitch Spreader

Most Common Parts

Spreader Vanes (Priced Each) (4 Used)
 ORDER # PA251023..... **\$ 5.95**
 Spreading Disc - With Vanes
 ORDER # PA251010..... **\$ 69.95**
 Adjustment Disc - 2 Hole
 ORDER # PA251018A **\$ 16.95**
 Adjustment Disc - 3 Hole
 ORDER # PA251019A **\$ 16.95**



DELUXE PULL SPREADER

300 Pound Capacity



**Ideal for Spreading Seed
 Fertilizer - Pellet Lime - Insecticides**

Pull with a Lawn mower, ATV or Small Tractor. Heavy Duty steel hopper with agitator. Material drops out bottom, Not the sides, provides easy cleaning. Spreads up to 28 Ft, depending on material. Center Spreading Only - Not Adjustable. No Assembly Required. Ships by Freight Truck.

ORDER # M-SP150 Weight 100 Lb. **\$ 715.00**

*Humble yourselves therefore under the
 mighty hand of God, that he may exalt you
 in due time. — 1 Peter 5:6*

**Parts for Model M-SP150 Pull Behind Spreader
 Most Common Parts**

Spreading Disc
 ORDER # SP51005..... **\$ 69.95**
 Vane (Priced Each) (4 Used)
 ORDER # SP51008..... **\$ 5.95**
 Adjustment Disc
 ORDER # PA251018A **\$ 16.95**

MANURE SPREADER

FEATURES:

Ground-driven (no-PTO) - Pulls with lawn tractor, atv or small tractor. No belts to slip - apron chain is ratchet-driven by one wheel ... beater is chain-driven by opposite wheel. 'Bear-claw' beaters quickly shred and spread all types of manure (including that mixed with straw or hay), plus shavings, grass clippings and compost. Simple to operate - up front controls for apron-chain and beater. Fully assembled - ready to go. Well balanced... for moving by hand ruggedly constructed. Performs just like the big expensive spreaders.

28 Cu. Ft. | Weight 455 lb
 ORDER # M-MX25 **\$2399.00**

GREAT FOR SPREADING FERTILIZER — FEED — SEED— CORN — SALT

FEATURES:

- LIFETIME WARRANTY:** On Electric Motor - 12 Volt High Torque
- SPINNER PLATES:** Comes with 2. Allows Variable Spreading Distance
- HOPPER:** Heavy tapered polyethylene resist rust & corrosion. 60 pound hopper.
- QUICK RELEASE LOCKING LID:** No danger of lid coming off during transport or spreading.
- MOUNTING:** See Mounting Styles Below
- REGULATING GATE:** Easy Adjust Poly Material Eliminates Sticking and Corrosion.
- SPECS:** Weight 32 Lbs - Diameter 18" - Height 31"
- HARNESS:** Included - 9Ft.

To Order The Bracket Only, Just Put the Letter B at the end of the Spreader Part Number.

Replacement Parts Are Available

\$ 169.95



Approximate Spreading Distance			
Plates	Deer Corn	Seed	Fertilizer
Triangle Shape	40-50 Ft	10-12 Ft	20-24 Ft
Ashtray Shape	4-6 Ft	4-6 Ft	4-6 Ft

CHOOSE YOUR MOUNTING STYLE

ATV MOUNTING

Mounts to Wire Mesh or Tubular Racks. Simple, Quick, Easy Mounting With Special Clamps
ORDER # 22005



2" RECEIVER MOUNT

FITS: 2" Receiver - Comes With Receiver Pin. Bracket Measures Center Hole To Bend 19" - 18" Tall
ORDER # 22002RHP



POLARIS ATV MOUNT

For Composite Made Racks
ORDER # 22001



UTV TRUCK STYLE MOUNT

Shown on a Kawasaki Mule. Bracket Slips Over Any Tailgate Width of 1-1/2"
ORDER # 22004



ADJUSTING ARM KIT

Allows you to adjust the amount of seed or fertilize being spread without getting off your ATV. Only Fits Older Models with Aluminum Gate
ORDER # 22000-AH



How does the spreader work?

Simply connect the wire harness # 08762 (Provided With Spreader) to Your ATV or UTV Battery. Then plug spreader into Harness. For Truck Applications Harness # 08760 (Sold Separately) is Required.

OPTIONAL Accessories

Hitch Adapter
Converts 1-1/4" to 2"
ORDER # ATV-CV \$ 24.95

ATV Wiring Harness, With On/Off Switch. Fused For Circuit Protection. Length 9Ft.
ORDER # 08762 \$ 19.95

Truck Wiring Harness With Cigarette Lighter Plug. Length 14 Ft.
ORDER # 08760 \$ 19.95

UTILITY RAKES

SWIVELS 360 Degrees

*Put Up The Rake.
This Makes Clean Up A Snap*

APPLICATIONS:

Roots - Limbs, Rocks - Trash
Leaves - Brush, Smooth Ground
Construction Trash, Heat Treated Spring Tines

6 Ft Model
ORDER # M-LR72S Weight 238 lb.....\$ 615.00

7 Ft Model
ORDER # M-LR84S Weight 269 lb.....\$ 660.00

Many Other Sizes Available



Replacement Tines

Heat Treated 5/16" Thick X 1" Width X 27" Overall Length .
Model LR72NS has two holes ORDER # 33913.....\$ 6.95 ea
Model M-LR72S has one hole ORDER # 10454.....\$ 6.95 ea

NON SWIVEL MODEL

FEATURES: 6ft Wide with 29 heat treated spring tines
- 5/16" thick x 1" wide. Heavy channel & angle iron
construction. Catagory 1 pins.

6 Ft Weight 265 lb
ORDER # LR72NS\$450.00



HANDY CARRY ALL

Ideal Applications

- Hauling Small Loads
- Fence Building
- Gardening
- Landscaping
- Moving Parts



Constructed of heavy angle iron. Flooring is heavy # 9 Expanded metal-No Rotting. Color bright red.
Size is 47" x 46". Comes With Cat. 1 Pins.
ORDER # HCA Weight 180 lb..... \$295.00

EQUIPMENT STAND



**CHECK OUT
OUR NEW
UNIVERSAL
EQUIPMENT
STAND ON
PG. 21.
MOUNTS TO
LIFT PIN
OR CAN BE
WELDED
IN ANY
POSITION**

HAY FORK



Also Great For Carrying Cross Ties.
FITS: Most pallets To Work As A Carry All

3 Point Hitch – Carries Small and Large Round Bales Easily. Made with 3" heavy Gauge Pipe. Heavy Constructed. Tine Width 44" - Tine Length 48". Carries Bales up to 1500 lbs
ORDER # M-HF1500 Wt. 165 lb..... \$450.00

FRONT LOADER HAY SPIKE



*60" Wide
HD Frame*

Head guard provides safe handling of hay. Fits most Dual cylinders. Rated capacity 1500 lbs. Brackets are Heavy angle iron and adjust up to 55". Pin holes are 1" Center spike 2" diam. x 40". Two lower stabilizer Spikes 1-1/4" diam. x 16" prevents hay from rolling. Constructed of heavy 3' square tubing

P/O Pictured **Pin On Style Model**
ORDER # CFLS1500 Wt. 220 lb \$ 495.00
Skid Steer Q/A Model
ORDER # CFLS1500-QA Wt. 230 lb..... \$ 675.00

3 POINT HITCH HAY SPIKE



Handles up to 1500 lb Round Bails. Fits Cat 1 or 2 Center Spike is 40" long with 2 Stabilizer Spikes. Constructed of 3" Square Heavy Wall Tubing. Center Spike is 2" in Diameter.

ORDER # CTPBS Wt. 150 lb..... \$300.00

FRONT LOADER HAY FORK

Dual Spears Makes Handling Bails Easier
 Also Works Great On Most Pallets



*60" Wide
HD Frame*

Head guard provides safe handling of hay. Fits Skid Steer QA Loaders. Rated capacity 2000 lbs. Dual Spears 2" diam. x 40" spaced at 30" center. Constructed of heavy 3' square tubing.

Q/A PICTURED **Skid Steer Q/A Model**
ORDER # CFLS2000-QA Wt. 260 lb.. \$ 650.00
Pin on Style Model
ORDER # CFLS2000 Wt. 250 lb..... \$ 550.00

BUCKET MOUNT HAY SPIKE



Mounts Easily to any Front End Loader Bucket Heavy Duty Constructed. Lifting Capacity of 1500lbs. Requires Drilling One Hole In Bucket. Easy to Mount and Remove
ORDER # BMS-K Wt. 150 lb..... \$295.00

TAPERED BALE SPEAR



Tapered Bale Spear 49" Length with Nut and Tapered Bushing. Rated at 2500 Lb Capacity.

ORDER # 44119C Wt. 30 Lb..... \$ 99.95
 Spear and Collar Available Separately



PANELS - GATES

Pound for pound, dollar for dollar, Priefert Panels and Gates are the toughest on the market.

“Tough Enough for Cattle, Safe Enough for Horses.”

These uniquely designed panels are light enough to be portable, yet heavy enough to be durable. Chain connections ensure tight connections and offer increased versatility to allow for connections over uneven ground and easy connections to existing structures.

Available in a variety of colors and also in galvanized



Utility Panel With J Hook Tops and other styles available



Many Style Gates Including Bull Gates



Bow Gates

Come By And See Us Or Give Us A Call For Size, Pricing And Color Options!

We Have Something To Fit Every Budget
Come By and See Us Or Give Us A Call at 1-800-333-9143.

SQUEEZE CHUTES

With four different squeeze chutes to choose from, Priefert has the right chute to fit your herd. Ease of access to the animal and one man operation makes these chutes #1 on the market.

We also handle roping chutes.



We Also Handle Head Gates And Many More Accessories For Your Farm And Ranch Needs. Come In And See Us Or Give Us A Call at 1-800-333-9143.

FEEDERS AND WATER TANKS



We carry a Variety of Feeders and Water Tanks for all your Ranching Needs

ARENA GROOMER



Priefert's ArenaMaster™ eliminates expensive hydraulics and allows operators to break packed ground, pulverize clumps of dirt, and leave consistent footing; often in a single pass. Offset rows of S-tines provide multiple points for ground breaking efficiency and to minimize large clods. Penetration depth can be regulated by changing the tractor's top link, lift control height, and/or the ArenaMaster's™ leveling bar adjustment. The leveling bar also aids in the breaking clods, leveling high spots, and filling in holes. The trailing "Clump Buster" further pulverizes dirt clods and packs the sub-surface for consistent footing; it also fluffs the top layer of dirt to ensure a smooth surface, suitable for any practice or competitive arena.

ROUND PENS



Round Pens will fit the needs of most any horse owner looking for a safe environment for working horses.

Whether you are starting a young colt or working with a seasoned horse, there are few training tools for all disciplines that can pay off like a Priefert Round Pen.

Chain connectors make these pens quick and easy to set up, while the lightweight panels allow this round pen to be portable. The 64" tall panels are tall enough to discourage horses from jumping on or over them.

The Architectural Grade Powder Coat Finish helps the product to resist rust, scratches, and fading to add years of life to your investment.

I have been crucified with Christ; it is no longer I who live, but Christ Lives in me.
— Galatians 2:20a

ORDER #	Diameter	Components	PRICE
Economy			
RP40	40'	10 - 12' Panels, 1- 6'x9' Bow Gate	\$1125.00
RP50	50'	13 - 12' Panels, 1- 6'x9' Bow Gate	\$1425.00
RP 60	60'	15 - 12' Panels, 1- 6'x9' Bow Gate	\$1625.00
RP70	70'	18 - 12' Panels, 1- 6'x9' Bow Gate	\$1925.00
Utility			
UP40	40'	10 - 12' Panels, 1- 6'x9' Bow Gate	\$1345.00
UP50	50'	13 - 12' Panels, 1- 6'x9' Bow Gate	\$1665.00
UP60	60'	15 - 12' Panels, 1- 6'x9' Bow Gate	\$1880.00
UP70	70'	18 - 12' Panels, 1- 6'x9' Bow Gate	\$2200.00
Premier			
PP40	40'	10 - 12' Panels, 1- 6'x9' Bow Gate	\$1995.00
PP50	50'	13 - 12' Panels, 1- 6'x9' Bow Gate	\$2500.00
PP60	60'	15 - 12' Panels, 1- 6'x9' Bow Gate	\$2850.00
PP70	70'	18 - 12' Panels, 1- 6'x9' Bow Gate	\$3360.00

SWEEP SYSTEMS

This rugged, completely reversible 180 Degree crowding system can be used as part of a permanent or portable working corral. It provides a durable and affordable crowding system that helps reduce the labor needed for working cattle.

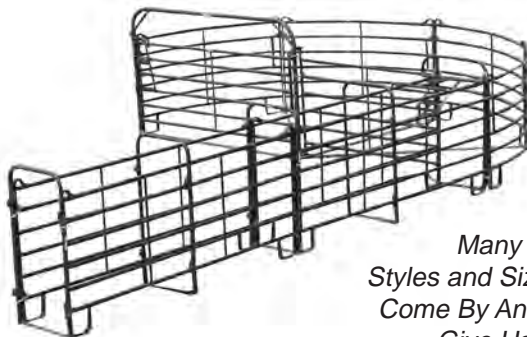

Many Other Styles and Sizes Available. Come By And See Us Or Give Us A Call!

ALLEY STOP

Priefert's Universal Alley Stop is the perfect solution to help prevent cattle from backing out of an alley. With no tools required, the effective height of the "no-back" Alley Stop can be quickly set to prevent the backing of bulls, cows, and calves. Designed for use with any Priefert Sweep System. Two chain connectors on the frame secure the ALLEY STOP to the alley panels.



ORDER # ASU
\$ 160.00

Many Other Accessories Available. Come By And See Us Or Give Us A Call!

FISH FEEDERS

THREE GREAT TIMERS TO SELECT FROM

With A Lifetime Hassle Free Warranty

LIFETIME



All Timers Slide Out From The Bottom of The Housing for Easy Access.



TIMER FEATURES
24 Hour Quartz Clock

Run Time: Adjustable 4-12 Seconds
Feed Settings: 1-12 Times Per Day
Batteries: Eleven AA

Timer Only
ORDER # 50000.....**\$119.95**

THE ELITE



TIMER FEATURES
All Digital - Simple & Easy

Run Time: Adjustable 1-30 Seconds
Feed Settings: 1-6 Times Per Day
Batteries: Ten AA

Timer Only
ORDER # 50001.....**\$ 139.95**

SOLAR ELITE



TIMER FEATURES
All Digital - Simple & Easy

Run Time: Adjustable 1-30 Seconds
Feed Settings: 1-6 Times Per Day
Batteries: One 6 Volt Gel Cell - Rechargeable (Included)

Timer Only
ORDER # 11116**\$174.95**

SELECT THE FEEDER OF YOUR CHOICE

HANGING



FEATURES: A 225 Lb Capacity Poly Barrel With Conical Bottom

Choose Any On Time Fish Feeder Timer

Comes With All Necessary Hardware
Post Not Included

All Fish Feeders Now Come With New Conical Bottom Barrel

No Internal Funnel To Mess With

**** Can SHIP FedEx ****
*** Additional Shipping Charges Required.**

Therefore, do not be ashamed of the testimony of our Lord, nor of me His prisoner, but share with me in the sufferings for the Gospel according to the power of God. — 2 Timothy 1:8

TIMER	ORDER #	PRICE
LIFETIME	F-50000	\$169.95
ELITE	F-50001	\$187.95
SOLAR	F-11116	\$221.95

DOCK POST MOUNT



TIMER	ORDER #	PRICE
LIFETIME	F-50000-DP	\$174.95
ELITE	F-50001-DP	\$194.95
SOLAR	F-11116-DP	\$229.95

AQUA PRO AIR-DRIVE DIRECTIONAL FISH FEEDER



The **Aqua Pro Fish Feeders** are the most popular fish feeder in the industry today. Constructed of heavy gauge galvanized steel, making it the sturdiest unit available anywhere. All Internal seams are double sealed with silicone and industrial rubberized coating to help prevent moisture from affecting your valuable feed. Wiring is protected by 1/2" steel flex tube conduit to insure proper connection and years of trouble free service. **Made in the USA.**

GENERAL FEATURES:

Power Supply: 12 Volt Heavy Duty Re-Chargeable Gel Cell Battery with Solar Panel

Timer: Digital - Large, easy to read liquid crystal display. Simple - Easy Programming. 100% Solid State Electronics.

Feed Times: Feed up to 8 Times Daily

Run Time: Adjustable 1-90 Seconds per Feed Time

Warranty: Two Years

Assembly: Minor Assembly Required. No Special Tools needed.

Complete With

- Solar Panel
- 12 Volt Gel Cell Battery
- Digital Timer
- 110 Wall Charger

Specifications

Feed Size & Type	Capacity
Pellet Size - 1/8" to 1/2"	
Floating Pellet	75 Lb.
Sinking Pellet	112 Lb.
Corn	150 Lb.

ORDER # ADF-75D \$ 499.95

****Additional Shipping Charges Apply.**

Delivery Weight 70 Lb.



Approximate Spreading Pattern



Put on the whole armor of God, that you may be able to stand against the wiles of the devil. For we do not wrestle against flesh and blood, but against the principalities, against powers, against the rulers of the darkness of this age, against spiritual host of wickedness in heavenly places.

— Ephesians 6:9

ROTARY CUTTER BLADES

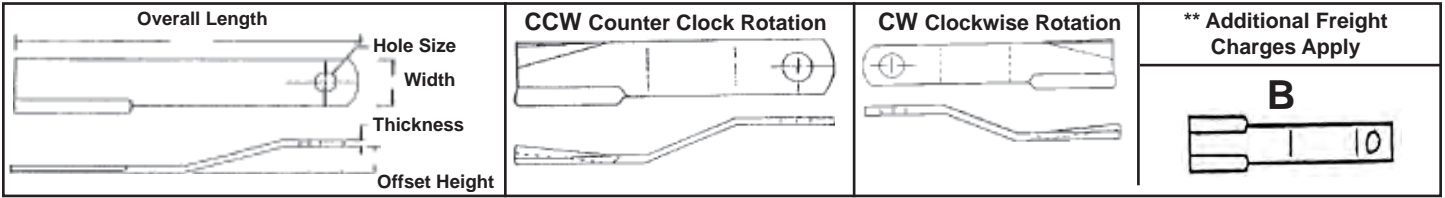

BUSHOG

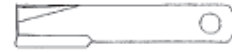

*** From Center Hole to End of Blade

Model Of Rotary Cutter	Ref	Length ***	Hole Size	Blade Width	Blade Thickness	Offset Height	Rotation CW/CCW	ORDER #	PRICED Per SET
60" - 12, 105, 205, 255, 266, 305, 502, 600, RB60, SQ60, SQ60-5, SQ600-3. OEM #462, 36BH	A	22-1/8"	1-1/2"	3-1/2"	1/2"	2"	CCW	125-1201	\$ 69.95
72" - 206, 256, 306, 1206, 1256, SQ72-4, SQ720, SQ720-3. OEM #463, 304BH	A	25-1/4"	1-1/2"	3-1/2"	1/2"	2"	CCW	125-1202	\$ 74.95
84" - 207, 257, 257-R, 307, 1207, 1257, 1257R-2, 1307. OEM #464	A	28-1/4"	1-1/2"	3-1/2"	1/2"	2"	CCW	125-1203**	\$ 81.95
109 LH (2 Used), 109 Offset (4 Used), 160 RH (2 Used), 166 RH (2 Used), 166 Center (2 Used) 1109 LH (2 Used), 1109 Offset (4 Used), 1166 RH & Center (2 Used), 1209 LH (2 Used), 1600 RH & Center (2 Used), 2512, 3108, 3108 Offset (4 Used), 3209, 3209 Offset (4 Used), 12512, 13108, 13108 Offset (4 Used). Updraft Blade. OEM #7828BH	A	16-3/4"	1-1/2"	4"	1/2"	2-1/2"	CCW	125-1204	\$ 69.95
109 RH (2 Used), 160 LH (2 Used), 166 LH (2 Used), 1109 RH (2 Used), 1166, 1209 RH (2 Used), 1600 LH (2 Used), 2512, 3108, 3209, 12512, 13108. Updraft Blade. OEM #7829BH	B	16-3/4"	1-1/2"	4"	1/2"	2-1/2"	CW UpDraft	125-1205	\$ 69.95
6 Uplift (2 Used), 12 Uplift (2 Used), 105 Uplift (2 Used), 126 LH (2 Used), 126 Offset (4 Used), 205 Uplift (2 Used), 266 Uplift (2 Used), 305 Uplift (2 Used), 310 RH (2 Used), 315 RH (2 Used), 502 Uplift (2 Used), 600 Uplift (2 Used), 1126 LH (2 Used), 1126 Offset (4 Used), 1226 LH (2 Used), 1310 RH (2 Used), 1315 RH (2 Used), 2010, 2315, 2415, 2510, 2610 RH, 2615 RH (2 Used), 3610 RH, 3615, 3715 RH, 12610 RH, 12615, BH25, RB60, SQ60, SQ60-5, SQ600-3. OEM # 7555	C	22-1/4"	1-1/2"	4"	1/2"	2-1/2"	CCW UpDraft	125-1206	\$ 69.95
206 Uplift (2 Used), 256, 276, 286, 306 Uplift (2 Used), 310 & 315 Center (2 Used), 1206, 1256, 1310 & 1315 Center (2 Used), 2315 Center, 2415 Center, 2610 Center, 2615 Center (2 Used), 2720, 3610 Center, 3615 Center, 3715 Center, 12610 Center, 12615 Center, BH26, SQ72-4, SQ172, SQ720, SQ720-3. UpDraft Blade. OEM # 7556	C	25-1/4"	1-1/2"	4"	1/2"	2-1/2"	CCW UpDraft	125-1207**	\$ 74.95
126 RH (2 Used), 315 LH (2 Used), 1126 RH (2 Used), 1266 RH (2 Used), 1315 LH (2 Used), 2010, 2315, 2415, 2510, 2610 LH, 2615 LH (2 Used), 3610 LH, 3615 LH, 3715 LH, 12610 LH, 12615 LH. UpDraft Blade. OEM # 11150	C	22-1/4"	1-1/2"	4"	1/2"	2-1/2"	CW UpDraft	125-1208	\$ 74.95
6 Ft Squealer - SQ72, SQ72-2, SQ72-3	A	28-1/4"	1-1/2"	3"	1/2"	2-1/2"	CCW UpDraft	67327	\$ 119.95
8 Ft - 268, 1268 Cutters LH. OEM # 67743	C	14-5/8"	1-1/2"	4"	1/2"	2-1/2"	CW UpDraft	67743	\$ 90.95
7 Ft Squealer - SQ84 8 Ft - 268 RH, 1268 RH. OEM # 67744	C	14-5/8"	1-1/2"	4"	1/2"	2-1/2"	CCW UpDraft	67744	\$ 90.95
5 Ft - RZ60, Razor Back RZ60 OEM # 81395	A	24-5/8"	1-17/64"	3"	3/8"	2-3/8"	CCW	81395	\$ 79.95
3008, 3214, 3368, 13368. Updraft Blade. OEM # 86664	C	18-1/4"	1-1/2"	4"	1/2"	2-1/2"	CCW - UpDraft	86664BH	\$ 79.95
3008, 3214, 3368, 13368. Updraft Blade. OEM # 86665	C	18-1/4"	1-1/2"	4"	1/2"	2-1/2"	CW - UpDraft	86665BH	\$ 79.95
2720, 12720. Updraft Blade.	C	27-3/4"	1-1/2"	4"	1/2"	2-1/2"	CW - UpDraft	90242	\$129.95

A



BUSHOG

continued



C

*** From Center Hole to End of Blade

Model Of Rotary Cutter	Ref	Length ***	Hole Size	Blade Width	Blade Thickness	Offset Height	Rotation CW/CCW	ORDER #	PRICED Per SET
207, 220 Center & RH, 257, 257R-2, 277, 287, 307, 1207, 1220 Center & RH, 1257, 1257R-2, 1287, 1307, 2620 Center & RH, BH27, SQ7, SQ840. UpDraft Blade. OEM# 7557	C	28-1/4'	1-1/2"	4"	1/2"	2-1/2"	CCW Lift	125-1210	\$ 89.95
220, 2620 LH (2 Used), UpDraft Blade. OEM # 60528	C	28-1/4'	1-1/2"	4"	1/2"	2-1/2"	CW Lift	125-1211	\$129.95
3126 (4 Used), 3126R, 3126S, 3210, 13126R, 13126S. UpDraft Blade. OEM # 78494	C	21-1/2"	1-1/2"	4"	1/2"	2-1/2"	CW Lift	125-1212	\$ 85.95
3126 (4 Used) - (2) RH & (2) Center, 3126R, 3126R Offset, 3126S, 3126S Offset, 3210, 13126R, 13126S. OEM # 78495	C	21-1/2"	1-1/2"	4"	1/2"	2-1/2"	CCW Lift	125-1213	\$ 85.95
6 Ft - Extra Heavy Duty Blade 406, 1406. OEM # 7278	A	25-1/4"	2"	5"	5/8"	2-5/8"	CCW	7278	\$179.95

Measure your blades before Ordering

BIG BEE

*** From Center Hole to End of Blade

Model Of Rotary Cutter	Ref	Length ***	Hole Size	Blade Width	Blade Thickness	Offset Height	Rotation CW/CCW	ORDER #	PRICED Per SET
42" AG42	A	16'	1-1/2"	3"	1/2"		CCW	628	\$ 81.95
48" AG4, L440, LW440	A	19"	1-1/2"	3"	1/2"		CCW	629	\$ 59.95
60" AG5, L540, L560, LW540	A	25"	1-1/2"	3"	1/2"		CCW	630	\$ 59.95
66" AG66 - Heavy Duty Blade	C	25-1/4"	1-1/2"	4"	1/2"	2-1/2"	CCW Lift	125-1207	\$ 74.95
72" AG72, L660	A	30-1/2"	1-1/2"	3"	1/2"		CCW	631**	\$ 79.95

While Supplies Last

FORD

*** From Center Hole to End of Blade



A

Model Of Rotary Cutter	Ref	Length ***	Hole Size	Blade Width	Blade Thickness	Offset Height	Rotation CW/CCW	ORDER #	PRICED Per SET
For 60" Mowers, 505, 901, 908, 909, 910, 22-47, 22-60, 22-70, 22-99, 22-100, 22-111, 22-113, 22-117, 22-118, 22-119, 22-127, 22-127A, 22-140, 22-141, 22-171, 22-172, 22-176, 22-177, 22-178, 22-179, 22-194, 22-195, 22-196, 22-197, 22-198, 22-199, 22-220, 22-221, 22-222, 22-223.	A	20-1/2"	1-1/2"	3"	3/8"	2"	CCW	125-1101	\$ 79.95

**** Additional Freight Charges Apply**

HARDEE

*** From Center Hole to End of Blade



B

Model Of Rotary Cutter	Ref	Length ***	Hole Size	Blade Width	Blade Thickness	Offset Height	Rotation CW/CCW	ORDER #	PRICED Per SET
52LT, 60LT, 60LTO, 66LT, 66LTO, 72LT, T160, T160LT, T160LTO, T166, T166LT, T172, T172LT, T172LTO, H-CO, HS260CO, H360CO. (Not for 66" & 72" With Round Blade Holders).	A	20-1/2"	1-1/2"	3"	1/2"	2-1/2"	CCW	C49RC	\$ 79.95
T160, T160LT, T160LTO, T166, T166LT, T166LTO, T172, T172LT, T172LTO, H-CO. (Not for 66" & 72" with Round Blade Holders).	B	20-1/2"	1-1/2"	3"	1/2"	2-1/2"	CW or CCW	C49ND	\$ 89.95
T8398, LT & PT, T8714, 1198, 10126. UpDraft blade.	A	16-1/2"	1-1/2"	3"	1/2"	2"	CCW Lift	C50RC	\$ 79.95

ROTARY CUTTER BLADES

**** Additional Freight Charges Apply**

HICO - HOWSE

*** From Center Hole to End of Blade

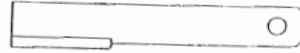

A

Model Of Rotary Cutter	Ref	Length ***	Hole Size	Blade Width	Blade Thickness	Offset Height	Rotation CW/CCW	ORDER #	PRICED Per SET
Model 350 - 42" Cut OEM # 419	A	16"	1-1/2"	3"	1/2"		CCW	628	\$ 81.95
4 Ft Series - LML419	A	19'	1-1/2"	3"	1/2"		CCW	629	\$ 59.95
5 Ft Series - 5002, 500, Series HL 421 OEM # 420	A	22-1/8"	1-1/2"	3-1/2"	1/2"	2"	CCW	125-1201	\$ 69.95
6 Ft Series - 600 Economy	A	28-1/4"	1-1/2"	3-1/2"	1/2"	2"	CCW	**125-1203	\$ 81.95
6 Ft Series - 6002 Heavy Duty OEM # 422	A	25-1/4"	1-1/2"	3-1/2"	1/2"	2"	CCW	125-1202	\$ 74.95
7 Ft Series - 7002 Heavy Duty	A	33-5/8"	1-1/2"	3"	1/2"			423	\$149.95
Boss 10 - 10 Ft Cut RH (HD1208) OEM 422RH	A	22-1/4"	1-1/2"	4"	1/2"	2-1/2"	CCW-Updraft	125-1206	\$ 69.95
Boss 10 - 10 Ft Cut LH (HD1208) OEM 422LH	A	22-1/4"	1-1/2"	4"	1/2"	2-1/2"	CW-Updraft	125-1208	\$ 74.95

**** Additional Freight Charges Apply**

KODIAK

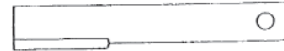

A

Model Of Rotary Cutter	Ref	Overall Length	Hole Size	Blade Width	Blade Thickness	Offset Height	Rotation CW/CCW	ORDER #	PRICED Per SET
4' Cutters	A	19"	1-1/2"	3"	1/2"		CCW	**K213	\$ 89.95
5' Cutters - Standard Duty	A	24-3/4"	1-1/2"	3"	1/2"	2-1/2"	CCW	**K214	\$ 89.95
6' & 7' Cutters - Standard & Medium Duty	A	30-3/4"	1-1/2"	3-1/2"	1/2"	2"	CCW	**K212	\$ 144.95
6' & 7' Cutters - Heavy Duty	A	30-1/4"	1-1/2"	4"	1/2"	3-1/2"	CCW	**K210HD	\$ 149.95
8' Cutters - Right Hand	A	19"	1-1/2"	3"	1/2"		CCW	**K213	\$ 89.95
8' Cutters - Left Hand	A	19"	1-1/2"	3"	1/2"		CW	**K213R	\$ 89.95
10' Cutters - (LH - Use K214R) (RH - Use K214)	A	24-3/4"	1-1/2"	3"	1/2"	2-1/2"	CW	**K214R	\$ 89.95

Measure your blades before Ordering

IMCO - SOUTHEAST

*** From Center Hole to End of Blade

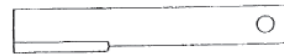

A

Model Of Rotary Cutter	Ref	Length ***	Hole Size	Blade Width	Blade Thickness	Offset Height	Rotation CW/CCW	ORDER #	PRICED Per SET
1502, 6 Ft. OEM # 1502	A	28-1/4"	1-1/2"	3-1/2"	1/2"	2"	CCW	125-1203	\$ 81.95

Blades for Modern Cutters Available.

JOHN DEERE

*** From Center Hole to End of Blade



B

Model Of Rotary Cutter	Ref	Length ***	Hole Size	Blade Width	Blade Thickness	Offset Height	Rotation CW/CCW	ORDER #	PRICED Per SET
509, 609, 709, 1008, 1508. OEM # W43048	B	19-3/4"	1-1/2"	4"	1/2"	2-3/4"		W43048	\$ 99.95
509, 609, 709, CX15 (SN # WOCX15X002230 & up), CX20, HX10, HX15 (SN # WOHX15X004260 & up), HX20, MX15. Updraft Blade. OEM # 404-49171	A	19-3/4"	1-1/2"	4"	1/2"	2-3/8"	CCW - Updraft	W49171	\$ 79.95
CX15 (SN # WOCX15X002230 & up), CX20, HX10, HX15 (SN # WOHX15X004260 & up), HX20, MX15. Updraft Blade. OEM # 404-49170	A	19-3/4"	1-1/2"	4"	1/2"	2-3/8"	CW - Updraft	W49170	\$ 79.95
CX15 (SN # WOCX15X003750 to 005499); HX15 (SN # WOHX15X008500 to 012299); Used with AW33172 Blade Pan on Center Wing. Updraft Blade. OEM # 404-52742	A	25-1/4"	1-1/2"	4"	1/2"	2-3/4"	CCW - Updraft	W52742	\$ 89.95

ROTARY CUTTER BLADES

LANDPRIDE

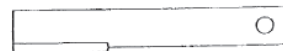

A

*** Overall Length - unless noted otherwise - the 1251206 & 1251210 are center hole to end

Model Of Rotary Cutter	Ref	Length ***	Hole Size	Blade Width	Blade Thickness	Offset Height	Rotation CW/CCW	ORDER #	PRICED Per SET
15 Ft LH	A	25-3/4"	1-1/2"	4"	1/2"		CW	**820-091C	\$ 129.95
15 Ft RH	A	25-3/4"	1-1/2"	4"	1/2"		CCW	820-092C	\$ 129.95
15 Ft Center	A	29"	1-1/2"	4"	1/2"		CCW	**820-090C	\$ 149.95
RCR1560 & RCR1860 - 60"	A	25"	1-1/2"	3"	1/2"		CCW	820-198C	\$ 89.95
RCR1572 - 72"	A	31"	1-1/2"	3"	1/2"		CCW	**820-199C	\$ 99.95
RCR2560 - 60" & RCR2572 - 72"; Replaces: 820-137C	A	22-1/4"	1-1/2"	4"	1/2"	2-3/4"	CCW	125-1206	\$ 69.95
RCR84 - 84"; Replaces 820-138C	A	28-1/4"	1-1/2"	4"	1/2"	2-3/4"	CCW	125-1210	\$ 89.95

Check Your Blade Size Before Ordering

MOHAWK

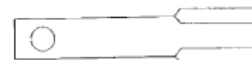

B

*** From Center Hole to End of Blade

Model Of Rotary Cutter	Ref	Length ***	Hole Size	Blade Width	Blade Thickness	Offset Height	Rotation CW/CCW	ORDER #	PRICED Per SET
507, 510 Heavy Duty & 507, 407 OEM # 1210 OEM # 7210	B	15"	1-1/4"	4"	1/2"		CW/CCW	125-1301	\$ 74.95
840, 1360 Regular, 1460 RH UpDraft	B	17"	1-1/2"	4"	1/2"		CW/CCW	125-1302	\$ 79.95
840, 1360 UpDraft CLOSE-OUT OEM # 1215	B	17"	1-1/2"	4"	1/2"		CW/CCW	125-1303	\$ 79.95

SIDEWINDER



A



C

*** From Center Hole to End of Blade

Model Of Rotary Cutter	Ref	Length ***	Hole Size	Blade Width	Blade Thickness	Offset Height	Rotation CW/CCW	ORDER #	PRICED Per SET
SX50, GB50. OEM # 8588.	B	15-3/8"	1-1/2"	3"	3/8"	2"	CW/CCW	21301	\$ 74.95
5X5, K60, SX60. OEM # 17065.	A	20-3/8"	1-1/2"	3"	3/8"	2"	CCW	125-1403	\$ 69.95
GM60, MG5. OEM # 25990.	A	20-1/2"	1-1/2"	3"	1/2"	3"	CCW	C49RC	\$ 79.95
GB 6, SW 7, GB 7, GM 72, MG 6	A	29-1/2"	1-1/2"	3-1/2"	1/2"			**25899	\$ 99.95
GB48, GM66 (Tire Driven), GM144, RS160, RS213, SW66 (Tire Driven). OEM # 15074.	A	17-3/4"	1-1/2"	3-1/2"	1/2"	4"	CCW	125-1406	\$ 71.95
605, 660, GB60, GB602, SW72 (Tire Driven). OEM # 15096.	A	20-1/4"	1-1/2"	3-1/2"	1/2"	2-3/4"	CCW	125-1401	\$ 89.95
6X6, GB722, GB842, SW642. OEM # 15120.	A	26-1/4"	1-1/2"	3-1/2"	1/2"	3"	CCW	125-1402	\$ 99.95
PG210. OEM # 125-1452.	A	22-3/8"	1-1/2"	3"	1/2"	3"	CW/CCW	125-1452	\$ 94.95
FW215, FW315, FW325, FW425; For LH Side. OEM # 22934LH.	C	22-3/4"	1-1/2"	4"	1/2"	3-1/8"	CCW-UpDraft	125-1404	\$ 89.95
FW215, FW315, FW325, FW425; For RH Side. OEM # 22935RH.	C	22-3/4"	1-1/2"	4"	1/2"	3-1/8"	CW-UpDraft	125-1405	\$ 94.95
FW15 (6 Used) (While Supplies Last)	B	23"	1-1/2"	3-1/2"	1/2"	3-1/8"	CW/CCW	20013	\$ 119.95
FW425, 15 Ft. Center (2 Used)	C	25-5/8"	1-1/2"	3-1/2"	1/2"			27485	\$ 89.95

ROTARY CUTTER BLADES

A



SERVIS RHINO

*** From Center Hole to End of Blade

C



Model Of Rotary Cutter	Ref	Length ***	Hole Size	Blade Width	Blade Thickness	Offset Height	Rotation CW/CCW	ORDER #	PRICED Per SET
SE 5 (SN # 13509 & Up). OEM # 00761319	C	22-3/4"	1-3/8"	3"	3/8"	1-1/4"	CCW	00761319	\$ 99.95
SE 6. OEM # 00772302	C	25-1/2"	1-3/8"	3"	3/8"	2-1/2"	CCW	772302	\$ 99.95
SE 7 (SN # 10039 & Up); Model TW84	C	28-1/4"	1-1/2"	4"	1/2"	2-1/2"	CCW	7520	\$ 159.95
SAT8 (After SN # 10340-10490), SR120, TW96 RH. OEM # 00753841. For 8' Cutters.	C	17-3/8"	1-1/2"	3-1/2"	1/2"	2-1/2"	CW - UpDraft	00753841	\$ 79.95
SAT8 (After SN # 10340-10490), SR120, TW96 LH. OEM # 00753842. For 8' Cutters.	C	17-3/8"	1-1/2"	3-1/2"	1/2"	2-1/2"	CCW - UpDraft	00753842	\$ 89.95
V12, DR15, SR10, SM66, S128, FS15, FR180, FR15, FR120, FR10, FR180, FN15, FN120, FN10, FM15, FM10, Flex 10, FL15, FL10, Cyclone 1008 RH, Flex 15 RH, SA15 RH. UpDraft Blade. OEM # 65201-RF.	C	22-1/2"	1-3/8"	4"	1/2"	3-1/2"	CW - UpDraft	125-1354	\$ 79.95
CY60, CY72, Cyclone 1008, FL10, FL15, Flex 10, Flex 15, Flex 15 Magnum, FN10, FN15, FN120, FN180, FR10, FR15, FR120, FR180, FS15, SR10, SR15, V12. UpDraft Blade. OEM # 62201-3F.	C	22-1/2"	1-3/8"	4"	1/2"	3-1/2"	CCW - UpDraft	125-1355	\$ 79.95
260, 272, 284, 472, 484, 2150, 6140, 6200, CY72, FL10, FL14, FL15, FL20, Flex 10, Flex 15, FM15 Magnum, FN14, FN20, FR10, FR15, FR162, FR240, SR10, SR10M, SR12, SR14, SR15, SR15M, SR162, SR18, SR20, SR240; OEM # 58201-3F.	C	25-1/2"	1-3/8"	4"	1/2"	3-1/4"	CCW	125-1356	\$ 89.95
1310, SR166. OEM # 68-106-3.	B	17-1/8"	1-3/8"	4"	1/2"	1-3/4"	CW/CCW	125-1357	\$ 79.95
EC60, SC80 — CALL for AVAILABILTY		15-11/16"	1"	3"	.40"		CCW	125-1360	\$ 84.95
260, 272, Cyclone 60, Flex 15, FL10M LH & RH, FL15M LH & RH, GR60, S128. OEM # 065-201-0030.	B	22-1/2"	1-3/8"	4"	1/2"	3-1/2"	CW/CCW	125-1361	\$ 99.95
Saturn 5 & SE 6, Flex S-15. OEM # 71-103.	C	22-3/4"	1"	3"	3/8"	3"	CCW - UpDraft	125-1362	\$ 89.95
Saturn 8 Ft. OEM # 0731340000.	C	18"	1"	3"	3/8"	4-1/2"	CW - UpDraft	125-1363	\$ 99.95
Saturn 8 Ft OEM # 0731350000		18"	1"	3"		4-1/2"	CCW - Lift	125-1364	\$ 96.95
Cyclone 72 (Main Blade), Flex 15 (Center Blade), FL10M (Center Blade), FL15M (Center). 4150, 4155. OEM # 582013F.	B	25-1/2"	1-3/8"	4"	1/2"	3-1/4"	CCW	125-1365	\$ 94.95
SR15 LH Wing, SR15M LH Wing UpDraft Blade; 4150, 4155. OEM # 00759338.	C	19-1/2"	1-3/8"	4"	1/2"	3"	CW - UpDraft	125-1366	\$ 89.95
SR15 RH Wing, SR15M RH Wing. UpDraft Blade; 4150, 4155; OEM # 00759339.	C	19-1/2"	1-3/8"	4"	1/2"	3"	CCW - UpDraft	125-1367	\$ 84.95
HF315, PC1547, PC1547A, SE10-4, SE15, SE15-4, SR10M, SR15M, SR60, SR72, Super Flex 10, Super Flex 15, TW72. UpDraft Blade. OEM # 8588.	C	24-1/4"	1-1/2"	4"	1/2"	2-1/2"	CCW - UpDraft	125-1370	\$ 89.95
A960, HF315, PC1547, PC1547A, SE10-4, SE15, SE15-4, SR10M, SR15M, SR60, SR72, Super Flex 10, Super Flex 15, Turbo 120, TW60. OEM # 8589A.	C	18-1/8"	1-1/2"	4"	1/2"	2-1/2"	CCW - UpDraft	125-1371	\$ 84.95
HF315, PC1547, PC1547A, DE10-4, SE15, SE15-4, SR10M, SR15M, Super Flex 15, Turbo 120, TW120. OEM # 8590A.	C	18-1/4"	1-1/2"	4"	1/2"	2-1/4"	CW - UpDraft	125-1372	\$ 89.95
SD15, SE10-4A, SE15-4A, SX15, TW60, TW72	A	20-12"	1-1/2"	4"	1/2"	2-1/4"	CCW	775267	\$ 99.95
SD15, SE10-4A, SE15-4A, SX15	A	20-1/2"	1-1/2"	4"	1/2"	2-1/4"	CW	776973	\$ 99.95
(SD15 Center Blade), SE10-4A, SE15-4A, SX15, TW60, TW72	A	26-1/2"	1-1/2"	4"	1/2"	2-1/4"	CCW	775233	\$ 120.95
Model TW144	A	24-3/8"	1-1/2"	4"	1/2"	2-1/2"	CW	00761273	\$ 147.95

A



B

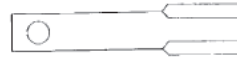

C



TERRAIN KING

Model Of Rotary Cutter	Ref	Overall Length	Hole Size	Blade Width	Blade Thickness	Offset Height	Rotation CW/CCW	ORDER #	PRICED Per SET
A1300M, A-Boom. OEM # 1215	B	12"	1-1/2"	5"	5/8"		CW/CCW	2726900	\$ 107.95

**** Additional Freight Charges May Apply**

TIGER

Model Of Rotary Cutter	Ref	Overall Length	Hole Size	Blade Width	Blade Thickness	Offset Height	Rotation CW/CCW	ORDER #	PRICED Per SET
TRB-50C Bengal. OEM # 6521000	A	14-1/2"	1-3/4"	5"	5/8"	2"	CW	06521000	\$ 129.95

WOODS

Model Of Rotary Cutter	Ref	Overall Length	Hole Size	Blade Width	Blade Thickness	Offset Height	Rotation CW/CCW	ORDER #	PRICED Per SET
80, B080, B80, B80U, C080, C80, C80U, D08, D80, K4, MB80, M80. OEM # 3900RCB.	A	17-1/8"	7/8"	3"	3/8"	3/4"	CCW Twist	125-1501	\$ 104.95
312, 2090, D210R, D315, HD210R-2, HD210R-3, HD210R-4 (Early), HD315-4 (Early), MR105, R105, S105 (Early), S105-1, S105-2. OEM # 12892L.	A	21-3/8"	1-1/2"	4"	3/8"	2-5/8"	CCW UpDraft	125-1502	\$ 99.95
2090, D210R, D315, D315-2, D315-3, HD210R-4 (Early), HD315-4 (Early), HS105, HS105-1, HS105-2, HS105-3, S105 (Late), S105-3. OEM # 24771R.	A	21-1/2"	1-1/2"	4"	3/8"	2-5/8"	CW UpDraft	125-1503	\$ 109.95
60-4, E60, M5, M60. OEM # 6866.	A	20-1/2"	1-1/2"	3"	3/8"	2-3/8"	CCW Twist	125-1505	\$ 69.95
Brushbull Series: BB48, BB48E, BB48X, BB60, BB60E, BB60X, BB72, BB72E, BB72X, BB84, BB84E, BB84X. OEM # 15326.	A	20-1/2"	1-1/2"	3"	3/8"		CCW	15326KT (Set)	\$ 129.95
72, 84, 213, 320, B315-4, MD172, MD184, M72, M84, XT184. OEM # 6323.	A	27-3/8"	1-1/2"	4"	3/8"	1-1/2"	CCW	125-1507	\$ 119.95
Model 114 (4 Used). OEM # 3915.	A	18-5/8"	7/8"	3-1/2"	3/8"		CCW	125-1509	\$ 79.95
Model 114 (2 Used). OEM # 3917.	A	13-7/8"	7/8"	3-1/2"	3/8"		CCW	125-1510	\$ 69.95
BB720, BB840, 3180 (LH & Center), BW180-3, HD315-5. OEM # 19160.	A	22-3/4"	1-1/2"	4"	1/2"	3"	CCW UpDraft	19160W Replacement	\$ 84.95
							CCW UpDraft	19160KT Original Woods	\$ 139.95
3180 (RH), BW180-3, HD315-5. OEM # 19161.	A	22-3/4"	1-1/2"	4"	1/2"	3"	CW UpDraft	19161W Replacement	\$ 84.95
							CW UpDraft	19161KT Original Woods	\$ 139.95

NOTE: Check Your Blade Size Before Ordering

Teach me your way, LORD, that I may rely on your faithfulness; give me an undivided heart, that I may fear your name.

— Psalm 86:11

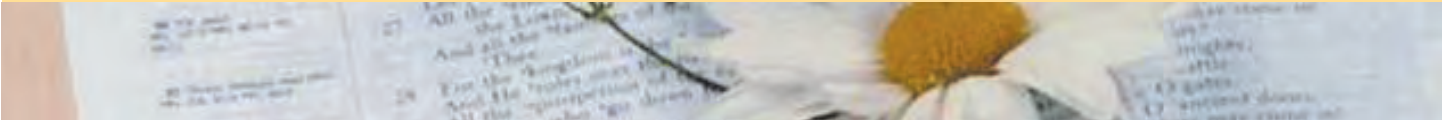

BLADE BOLTS

UNIVERSAL

**Bolt Kit Contains: (1) Bolt,
(1) Lock Washer and (1) Nut**



**FITS: Many BushHog Models.
Also fits Mohawk, Landpride & Tiger.**
ORDER # BH2500 **\$ 12.95**

OPTIONAL

FITS: Many Models
Contains the same parts
EXCEPT Bolt Length is 3"
ORDER # RC2500 **\$ 12.95**

BUSHHOG

**Bolt Kit Contains: (1) Bolt, (1) Lock
Washer and (1) Nut**

With Nut & Lock Washer

**FITS: RAZORBACK RZ60,
SQ36, SQ42, SQ420, SQ48,
SQ480, Model 104, 204 & 204H.**

Bolt Measurements
7/8" Bolt Diameter
3" Overall Length
3/8" Shoulder Thickness
1-1/4" Shoulder Diameter
RH Thread

ORDER # 1259BHKIT **\$ 15.50**

BIG BEE

**FITS: New Style
Cutters with Square
Bolt Hole Stump Jumpers.**
Consists of Bolt,
Washer & Nut.
ORDER # BB6321 **\$ 16.95**

*Be strong and of good courage,
fear not, nor be afraid of them,
for the Lord thy God, he it is that
does go with thee, he will not fail
thee nor forsake thee.*

JOHN DEERE

Bolt Kit Contains (1) Bolt and (1) Nut

**FITS: Models 506, 509, 606, 609,
709, 727, 737, 1008, 1408, 1418,
1508; Replaces: W22237, 2292A.**

Bolt Measurements:
1-1/8" Bolt Diameter
3-1/2" Overall Length
1-1/2" Blade Mount Diameter
1-1/2" Shoulder Length
Keyed on Both Sides
RH Thread

ORDER # W22237KIT **\$ 25.95**

**FITS: Models 509, 516, 609,
616, 709, 727, 737, 1008, 1018,
1418, 1508, 1517, 1518, 2018;
Replaces: W38686, W38134.**

Bolt Measurements
1" Bolt Diameter
1" Hex Shoulder
1-1/2" Round Shoulder Diameter
.77" Round Shoulder Length
3.63" Overall Length
** Contains Washer in Kit

ORDER # W38686KIT **\$ 18.25**

**FITS: Models; 403,
413, 503, 513,
(516 SN # 3526 & up),
603, 609, 613,
(616 SN # 4512 & up), 709, 717, 1517, CX15,
CX20, HX10, HX14,
HX15, HX20, LX4, LX5, LX6, MX5,
MX6, MX7, MX8, MX10, MX15;
Replaces: W38054, W50958.**

Bolt Measurements
1" Bolt Diameter
1" Hex Shoulder
1-1/2" Round Shoulder Diameter
.91" Round Shoulder Length
3-1/4" Overall Length
RH Thread

ORDER # W38054KIT **\$ 13.95**

FORD

**Bolt Kit Contains: (1) Bolt, (1) Washer,
(1) Spacer, (1) Cotter Key and (1) Nut**

**FITS: Models 901, 908,
909, 910, 22-47, 22-60, 22-70**

Bolt Measurements:
3/4" Bolt Diameter
3/4" Square Shoulder Diameter
2-3/8" Overall Length
RH Thread

ORDER # 309719..... **\$ 59.95**

HARDEE

**Bolt Kit Contains: (1) Bolt,
(1) Lock Washer and (1) Nut**

**FITS: 52LT, 60LT, 60LTO,
66LT, 66LTO, 72LT, HS260CO,
H360CO, T160LT, T160LTO,
T166LT, T166LTO, T172LT,
T172LTO;**
Replaces: 5548, 5547, 5545.

Bolt Measurements:
1-1/4" Bolt Diameter
3-3/4" Overall Length
1-5/8" Thread Length
Flat 2-1/2" Long.

ORDER # H2500 **\$ 21.95**

HICO-HOWSE

**Bolt Kit Contains: (1) Bolt, (1) Lock
Washer and (1) Nut**

FITS: Newer Style Cutters

Bolt Measurements:
1-1/8" Bolt Diameter
1/2" Tall Round Shoulder
1-1/2" Round Should Diameter
3/8" Square Shoulder.
3.63" Overall Length

ORDER # HBBSQ **\$ 13.95**

MODERN

Bolt Kit Contains (1) Bolt and (1) Nut

**FITS: Fits Various Models; Including
light duty Hardee cutters**
Replaces: 4010057.

Bolt Measurements:
1" Bolt Diameter
Left Hand Thread.

ORDER # 125902KIT **\$ 16.95**

MOHAWK

**Bolt Kit Contains: (1) Bolt, (1) Washer,
(1) Spacer and (1) Nut**

Bolt Measurements
7/8" Bolt Diameter
3" Overall Length

**FITS: Models with
1-1/4" Blade Hole**
ORDER # 722002..... **\$ 25.95**

**FITS: Models with
1-1/2" Blade Hole**
ORDER # 722001..... **\$ 27.95**

SERVIS RHINO

FITS: 260, 272,
Cyclones: 60, 72, 84, 128;
Flex 15, Gyro 60, 72, 84,
128, 160;
 Replaces: 571044, 0079018626



Bolt Measurements

1" Bolt Diameter
 1-3/8" Round Shoulder Diameter
 3.80" Overall Bolt Length
 LH Thread
 (1) Bolt, (1) Nut

ORDER # SRK2500..... \$ 19.95

FITS: Saturn 5, 6, 7 & 8,
Gyro 66 & 140.
 Replaces: 36-107-2ALH



Bolt Measurements

3/4" Bolt Diameter
 LH Thread
 (1) Bolt, (1) Nut

ORDER # 125908KIT..... \$ 19.95

FITS: Model 1310



Bolt Measurements

3/4" Bolt Diameter
 3-1/2" Overall Length
 RH Thread

Includes: (1) Bolt, (1) Nut
 (1) Bushing (2) Washers & (1) Nut

ORDER # 125910KIT..... \$ 23.95

FITS: Model SE5 & SE6



Bolt Measurements:

7/8" Bolt Diameter
 3" Overall Length
 Keyed
 RH Thread

ORDER # 00761402KIT \$ 23.95

FITS: Various Models;
 Including Models: **260, 272,**
Cyclones: 60, 72, 84, 128;
Flex 15, Gyro 60, 72, 84, 128, 160.

Square Hole Blade Bolt Bushing

1" ID Square Hole
ORDER # 571042B..... \$ 39.95

Square Hole Blade Spacer

1-1/8" ID Square Hole
 1/4" Thick
ORDER #0656150200..... \$ 6.95

BLADE BOLTS

SIDEWINDER

Bolt Kit Contains: (1) Bolt and (1) Nut

FITS: FW16, FW216,
GB602, GB605, GB607,
GB722, GB725, GB842, RS160,
RS213, SW66, SW72, SW84,
SW842; Replaces: 15060



Bolt Measurements:

1-1/8" Bolt Diameter
 RH Thread

ORDER # SW2500..... \$ 24.95

Bolt Kit Contains: (1) Bolt,
(1) Spacer and (1) Nut

FITS: 5X5, 6X6, GB50,
SX50, K60, SX60, GB90,
G90, GB108, OS108, OS210,
PG210;



For Blades 1/2" Thick.

ORDER # 27723SW..... \$ 18.95

For Blades 3/8" Thick.

ORDER # 27722SW..... \$ 18.95

SPACER ONLY

3/8" Thick
ORDER # 16197SW..... \$ 12.95



1/2" Thick
ORDER # 22132..... \$ 10.95

TERRAIN KING

Bolt Kit Contains: (1) Bolt, (1) Lock
Washer, (1) Roll Pin and (1) Nut

FITS: Alamo and Terrain
King Cutters A-Boom
with Pan Type Carrier, A1300M;
 Replaces: 02789200,
 02964330BK, , 02761500, 00020900.



Bolt Measurements:

3-1/2" Overall Length
 1-1/8" RH Thread Diameter
 1-1/2" Blade Mount Diameter
 For Pan Type BladeCarriers
 Roll Pin Measures 3/16" X 1-3/4"

ORDER # TK2502..... \$ 22.95

Bolt Kit for Dual Bar Blade Carrier Available
- Call 1-800-333-9143 for more information

TIGER

Bolt Kit Contains: (1) Bolt and (1) Nut

FITS: Various Models;
 Replaces: 6T1022R,
 6T1023R, 165354P.



Bolt Measurements:

1-1/8" Bolt Diameter
 High Round Shoulder
 Keyed

ORDER # RC26001 \$ 23.95

WOODS BLADE PIN

Pin Only - Measures 1-1/2" Diameter

FITS: M4, M5, 60, 72, 84,
C80, MC80, 120Q, R105,
5106, 5120, 210, D210R, B214,
B315, D320, SM2090.
 Replaces: 4622, 32606.
 2.4"



ORDER # 125903..... \$ 20.50

FITS: Models 2120, 2162, 3180,
3240, BB600, BB840, BB6000,
BB7200, BB8400, BW126, BW180,
DS120, DS1260, DS1440;
 Used on Blades 19160W
 and 19161W
 2.54"



Original Woods Bolt
ORDER # 32616..... \$ 29.95

Clamp Kit Includes:

(1) Keyhole Plate
and (1) Lock Clip;
 Replaces: 4623, 4624,
 32603, 32604.



ORDER # 7A6005..... \$ 7.95

*If you do not see what you are looking for -
 Call us Toll-Free and we will help find your parts.*

NUT ONLY FOR BOLTS

1"
Left Hand Thread
 Nylon Insert Locknut.
ORDER #125922..... \$ 4.25



3/4"
Left Hand Thread
ORDER # 125923..... \$ 5.95



1-1/8"
Right Hand Thread
Heavy Duty Gd 8
ORDER # 125924..... \$ 8.95



COMPLETE TAILWHEEL ASSY - HEAVY DUTY

\$169.95



- Fork Shaft Size —**
- 1-1/2" Diameter.
 - Overall Length 8

Complete Assembly

Consists of Heavy Duty Tail Wheel Hub with Bearings, Tail Wheel Fork, Axle Bolt and Tail Wheel

For 1" Axle

** ORDER # TWFA100..... \$169.95

For 3/4" Axle

** ORDER # TWFA..... \$169.95

**Assembly Required
Parts Broke Down For Shipping Purposes.**

HEAVY DUTY TAIL WHEEL HUB WITH BEARINGS

FITS: 4 X 8 Tailwheels
Four Bolt Pattern.
The **HUB Comes Complete**
With Races and Bearings,
Seals.



1" Axle
ORDER # TWHWB100 \$ 39.95

3/4" Axle
ORDER # TWHWB750 \$ 44.95

BEARING KIT

FITS: Heavy Duty Tail Wheel Hub. Consists of Bearings, Seals, Cups and Spacers



FITS: 1" Axle
ORDER # BHTWK10 \$ 21.95

FITS: 3/4" Axle
ORDER # BHTWK750 \$ 24.95

COMPLETE TAILWHEEL ASSY - ECONOMY

\$99.95



Fork Shaft Size —

- 1-1/4" Shaft diameter
 - 5-1/2" between forks
 - 1" Bolt hole diameter
 - 4-3/4" approximate length of shaft (for sliding up into housing on a bush hog)
- Fits Many Rotary Cutters

Complete Assembly

Consists of Economy Tail Wheel Hub, Tail Wheel Fork, Axle Bolt and Tail Wheel

For 1" Axle

** ORDER # \$ 99.95**

**Assembly Required
Parts Broke Down For Shipping Purposes.**

ECONOMY HUBS

FITS: Industry Standard Tail Wheel # TW500.
Fabricated steel hub with sintered bushings.
Four Bolt Pattern
Used On Lightweight Cutters.



1" ORDER # 49324 \$ 17.95
3/4" ORDER # 49642 \$ 17.95

ECONOMY HUB AXLE BUSHINGS



FITS: Above Hub Only
Priced Each

5/8" ORDER # 3252621 \$ 3.50
3/4" ORDER # 3252622 \$ 3.50
1" ORDER # 3252624 \$ 3.50

AXLE BOLT W/ NUT



5/8" x 7"
ORDER # 625BN \$ 4.95
3/4" x 7 1/2"
ORDER # 750BN \$ 8.95
1" x 7 1/2"
ORDER # 1000BN \$ 15.50

TAIL WHEEL FORK BUSHINGS

These bushings are weld-on replacements to hold the tailwheel fork. Comes with grease fitting. Bushings are 2-3/8" OD and 6" Long.



1-1/2" ID ORDER # 325-2198..... \$ 21.95

TAILWHEELS

4 X 8 Laminated Wheel

3-5/8" Center Hole
3-3/4" Wide
15-3/8" Outside Dia. (OD)



4 mounting holes
(1/2" on 5" bolt circle diameter)

Used on Many Rotary Cutter Brands.

** ORDER # TW500 \$ 39.95

6 X 9 Laminated Wheel

20" Diameter
5-1/4" Wide
5 Lug on 5-1/2" Bolt pattern



ORDER # 103211..... \$119.95

Heavy Duty Tailwheel Hub Bushings



1"
ORDER # 3252191 \$ 1.95

3/4" Reduced
ORDER # 3252195..... \$ 4.95



WHEEL RIM



For the 4 X 8 Tail Wheel
4 Bolt Hole
Comes as a Pair, With Bolts.
ORDER # BH233WB \$ 29.95

TAIL WHEEL FORKS

1-3/16" Shaft Dia

For Big Bee Rotary Mowers and Other Models

- 1/2" Thick X 3" Wide
- 1-3/16" Shaft Diameter
- 5-5/8" Shaft Length To Pin Hole
- 6-1/4" Overall Shaft Length
- 8-1/2" Wheel clearance
- 1" Axle Hole Size

ORDER # 646 \$ 61.95

For Lighter Applications

Measurements: Same as above.
Except 3/8" Thick X 2" Wide.

ORDER # 645 \$ 54.95



1-1/4" Shaft Dia

Heavy Duty

For Kodiak Cutters and many more brands.

- 1-1/4" Shaft diameter
- 5-1/2" Shaft Length to pin hole
- 6-1/8 Overall shaft length
- 5-3/8" Inside Fork width
- 8" Wheel clearance
- 3/4" Axle Bolt size

ORDER # 134H \$ 89.95



2" Shaft Dia

Heavy Duty

Found On The Heavy Duty Models.

- 3/4" Axle Hole Size
- 2" Diameter Shaft
- 4-3/4" Shaft to pin hole
- 5-3/8" Overall shaft length (for sliding up into housing on a bush hog)
- 8-1/4" Wheel Clearance
- 1" axle hole also available upon request.

**ORDER # HL303 \$ 122.95



1-1/4" Shaft Dia Fits Many Models

- 1-1/4" Shaft diameter
- 5-1/2" between forks
- 1" Bolt hole diameter
- 4-3/4" Shaft length to pin hole
- 5-1/4 Overall shaft length (for sliding up into housing on a bush hog)
- 8-1/4" tall inside the "U" where the wheel rides

ORDER # TWF63739 \$ 39.95



1-1/4" Shaft Dia Fits Many Models

- 1-1/4" Shaft diameter
- 5-1/2" between forks
- 3/4" Bolt hole diameter
- 4-3/4 Shaft to pin hole
- 5-1/4" approximate length of shaft (for sliding up into housing on a bush hog)
- 8" Wheel Clearance

ORDER # TWF63740 \$ 34.95



1-1/2" Shaft Dia

Heavy Duty

Material is 5/8" Thick X 3" Wide. With A Thick 3/4" Top Plate.

- 1-1/2" Shaft
- 3/4" or 1" Axle
- 7" Shaft to pin hole
- 7-3/4" Overall shaft length
- 9" Wheel Clearance

FITS: 3/4" Axle

**ORDER # TWF750 \$ 79.95

FITS: 1" Axles

**ORDER # TWF100 \$ 89.95



1-1/2" Shaft Dia Fits Many Models

- 1-1/2" Shaft diameter
- 5-1/2" between forks
- 1" Bolt hole diameter
- 4-3/4" Shaft length to pin hole
- 5-1/4" Overall shaft length (for sliding up into housing on a bush hog)

ORDER # TWF63741 \$ 39.95



Thou Shalt Love The Lord

Thy God With All Thy Heart,

and With All Thy Soul,

and With All Thy Mind.

— Matthew 22:37

AXLE BOLT W/NUT



5/8" x 7"

ORDER # 625BN \$ 4.95

3/4" x 7 1/2"

ORDER # 750BN \$ 8.95

1" x 7 1/2"

ORDER # 1000BN \$ 15.50

WELDED "A" FRAMES

Found on many Medium Duty Rotary Cutters. Can Be Bolted or Welded.

Steel 1/2" Thick, 3" Wide.

Overall Height 30".

With Cat 1 Pins, Wt. 68 lb

**ORDER # WAFMD \$129.95



"A" FRAME BRACKETS

FITS: Cat 1 Pins.

Heavy Duty 1/2" Thick, 2 1/2" Wide x 35" long.

Ideal for Rotary Cutters, Disc, anywhere a 3 Point Hitch is needed.

Painted Hi Gloss Black.

Top Holes and Lower Bottom Holes are 3/4" dia.

Cat 1 pin Mount Hole is 7/8" dia.

Sold by the pair.

**ORDER # UAFB Weight 26 lb..... \$ 54.95

All Parts Marked With ** Will Have Additional Freight Charges.

CHAIN LIMITER KIT

Hi - Test
1/4"
Chain



Heavy Duty.

Complete with chains and brackets. Fastens to Tractor top link pin, chain holders slips over CAT I. Implement pin. Hook chains through chain bracket and Set implement to desired height. It takes strain off the hydraulic lift. Great for tractors with weak lifts or finishing mowers that scalp the ground.

ORDER # CLK \$32.95

ROTARY CUTTER PARTS

UNIVERSAL STUMP JUMPERS

These stump jumpers are constructed from heavy duty steel to help prevent rocks and debris from breaking, clipping or getting caught in the blades.
 This Jumper will Interchange with **Most Big Bee, King Kutter, Bush Hog, Hico, Imco, SouthEast, Mohawk, Modern** and Many Other Rotary Cutters using 40HP Gearboxes.



1-1/2" OD Center Hub
 19-1/2" Overall Diameter
 13-1/2" Hole Centers
 Square Blade Bolt Holes
 Uses Blade Bolt # BB6321

12 SPLINE
 Center Hub
****ORDER # 621SQ..... \$ 139.95**



1-1/2" OD Center Hub
 20-1/4" Overall Diameter
 13-1/2" Hole Centers
 Round Keyed Blade Bolt Holes
 Uses Blade Bolt # BH2500 or RC2500

12 SPLINE
 Center Hub
****ORDER # 621AG \$ 129.95**



15 SPLINE
 Center Hub
****ORDER # 626SQ..... \$ 149.95**



15 SPLINE
 Center Hub
****ORDER # 626AG \$ 139.95**

HUBS FOR UNIVERSAL STUMP JUMPERS



12 Spline Hub
ORDER # 622..... \$ 24.95



15 Spline Hub
ORDER # 625..... \$ 29.95

SIDEWINDER

TIRE FOR TIRE DRIVEN!



Tire
FITS: Models with Tire Driven Cutters.
 Special Rib Tire, Size 6.70-15.
****ORDER # 15278**
Tube - For Above Models
ORDER # TUBE67015..... \$ 19.95

Call for availability

40 HP

UNIVERSAL GEARBOXES

75 HP

GEARBOX SEALS & PARTS

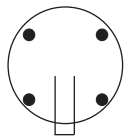

40 HP Universal Type Gearbox Found On Light Duty Rotary Cutters.
 12 Spline Output Shaft,
 1/2" Hole For Shear Bolt.
 Four Hole Mounting Bolt Pattern .
 Found Mostly On Cutters Up to 6 Ft.

40 HP Gearbox
 With 1-3/8" Smooth Input Shaft
****ORDER # DH40GB \$ 169.95**

40 HP Gearbox
 With 1-3/8" 6 Spline Input Shaft
****ORDER # DH40GB-Spline \$ 169.95**

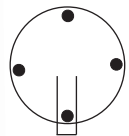

75 HP Universal Type Gearbox Found On Medium Duty Cutters.
 15 Spline Output Shaft.
 1/2" Hole For Shear Bolt -Splined
 Four Bolt Hole Mounting Pattern.

75HP Gearbox
 With 1-3/8" Smooth Input Shaft
****ORDER # GB75Smooth..... \$274.95**
75HP Gearbox

With 1-3/8" 6 Spline Input Shaft
****ORDER # GB75Spline..... \$ 274.95**

Found on Howse, Hico, King Kutter, Sidewinder and many other Cutters using 40HP Gearboxes



40HP Gearbox Input Seal
 2.125" OD (54mm)
 1.375" ID (34.93mm)
ORDER # 470135..... \$ 9.95



Output Seal
 2.129" OD (54mm)
 1.50" ID (38mm)
ORDER # 473227..... \$ 12.95



100HP Gearbox Input Seal
 2.378" OD (60.40mm)
 1.625" ID (41.27mm)
ORDER # 710358..... \$ 11.95



METRIC DRIVELINES

Used On Many Cutters Complete With Safety Shield
1-3/8" 6 Spline QD Yoke & 1-3/8" Smooth Round Bore Implement Yoke With 1/2" Hole For Shear Bolt.



FITS: Most 48" Cutters. Length 32".
**ORDER # MDL48 \$ 139.95

FITS: Most 60" Cutters. Length 37".
**ORDER # MDL60 \$ 139.95

FITS: Most 66" & 72" Cutters. Length 43".
**ORDER # MDL66 \$ 149.95

Many Other Sizes and Models Available

SHEAR BOLT WITH NUT (GRADE 2)

1/2" x 3-1/2"
Shear Bolt.
ORDER # SB35..... \$ 2.00



We Also Carry CVC Driveline Assemblies For \$869.00. Call For Application

SLIP CLUTCHES



1-3/8" Smooth Shaft on the Gear Box. PTO Driveline attaches to Male Shaft On Slip Clutch.
**ORDER # 32323..... \$ 139.95



1-3/8" 6 Spline Shaft on the Gear Box. Allows adding a Slip Clutch without having to change out Implement End Yoke.
**ORDER # 31951..... \$ 139.95
Uses Slip Clutch Disc
ORDER # 31953..... \$ 12.95



1-3/8" 6 Spline (Male Shaft)
1-3/8" 6 Spline Hub (Female End) For FDS4 Slip Clutch Fits 6, 7 & 8 Series PTO Shafts
ORDER # 36065..... \$ 189.95
Uses Slip Clutch Disc
ORDER # 31971..... \$ 13.95

SLIP CLUTCH DISC



Cutter Brand	OD	ID	ORDER #	Price
Bush Hog	6--1/2"	2--7/16"	3721BH	\$ 11.50
Bush Hog	6--5/16"	3--7/8"	31971	\$ 13.95
Bush Hog	6--1/2"	1--5/32"	374	\$ 15.95
Ford Howse	6--1/2"	2"	202227	\$ 10.95
Ford Howse	6--1/2"	2--1/2"	SC303132	\$ 8.95
John Deere	6--1/2"	4--1/2"	39301	\$ 8.95
Kodiak	6--5/16"	3--7/8"	31971	\$ 13.95
Servis / Rhino	7"	3--7/8"	0581060003	\$ 7.95
Sidewinder	5"	2--5/8"	18309	\$ 21.50
Sidewinder	6"	3--1/2"	27683	\$ 12.95
Universal	6--1/2"	2--1/2"	SC303132	\$ 8.95
Universal	6--5/16"	3--7/8"	31971	\$ 13.95
Universal	5--1/2"	3--3/8"	31953	\$ 8.95
Vermeer	10"	6--7/8"	SC614R	\$ 11.95
Woods	6--1/4"	4"	7280WD	\$ 7.95

NOTE: Yellow clutches are by Eurocardan and are heavier than the black clutches

UNIVERSAL SLIP CLUTCH

FITS: Caldwell, Dimmick, Covington, Dixie, Hardee, Harrington, Imco, Marvel, Modern, Mohawk, Mono, SideWinder, Terrain King, Vermeer And Various Others.



Clutch Assembly Complete.
ORDER # SC303219..... \$ 169.95



Hub Assembly (6 Spline)
ORDER # SC303216..... \$ 77.95



Nut, Malleable Iron,
ORDER # SC303218..... \$ 26.95



Friction Disc, 2 Required Priced Per one.
ORDER # SC303132..... \$ 8.95



Spring
ORDER # SC303076..... \$ 29.95



Brass Center Ring For Late Production Slip Clutch SC303219. Prevents Hub For Binding Against Plate Because Of Rust Build-Up. Cannot Be Used In Early Production Clutches Where Hub Comes In Contact With Plate. Disassembly Is Required For Identification.
ORDER # 090110101..... \$ 19.95

ATTACHMENT YOKE

Attachment Yoke For Torque Limiters (Slip Clutches) 4-Bolt Mount on 7-1/16" Centers



35N Slip Clutch Yoke
ORDER # 35NTLF \$ 99.95

FRICITION DISC FOR FLEXIBLE COUPLERS

FITS: Many Models Dimensions are 6" OD, 2-1/4" Center Hole, with (6) 5/8" Holes. For Flexible Couplings. 3/8" Thick. Priced Per ONE.
ORDER # 11374BH..... \$ 39.95



Kodiak Coupler Disc Pad
ORDER # 115120P \$ 99.95

Don't wait for 6 strong men to take you to church.



MOWER BLADES

BIG BEE

Model	Wdt.	Len.	Hole Size	ORDER #	Price Set
All 48" Rear Mount	2 1/2"	19"	1/2"	BBRM48	\$ CALL
All 60" Rear Mount	2 1/2"	20"	1/2"	BBRM60	\$ 68.95
All 72" Rear Mount	2 1/2"	25"	1/2"	BBRM72	\$ 71.95
All 84" Rear Mount	2-1/2"		1/2"	BBRM84	\$ 89.95

BUSHOG

All BushHog Blades are ORIGINAL BushHog
Unless Noted Otherwise with Replace above the ORDER Number

Model	Wdt.	Len.	Hole Size	ORDER #	Price Set
ATV Pull Behind Mowers GT42 - Single Blade				81577	\$155.95
GT48 - 2 Blades				50024673	\$ 84.95
Models EFM480, TH48-01, TH48-02 Most 48" Mowers OEM# 82323 (Set of 3) Up-Lift	2-1/4"	17"	1/2"	82323	\$ 93.95
Model FTH480 (2 Blades Used) OEM# 82325	2-1/4"	25"	1/2"	Replace 910342	\$ 40.95
Models EFM600, FTH600, RDTH60, TH60-01 60" Mowers OEM # 82324	2-1/4"	21"	1/2"	Replace 91071	\$ 66.95
Model MTH600 OEM# 95754 - CW (Set of 3) Low Lift		21"		95754	\$134.95
Model ATH600 OEM# 88668		21"	1/2"	Replace 91035	\$ 69.95
Models FTH720, RDTH72, TH72-01 72" Mowers OEM# 82325	2-1/4"	25"	1/2"	Replace 91034	\$ 64.95
Model MTH720 OEM# 95755 - CW (Set of 3) Low Lift		25"		95755	\$149.95
Model ATH720 OEM# 88773	2-1/2"	25"	1/2"	Replace 91036	\$ 69.95
Model RDTH84 OEM# 50033779 Offset - UpLift		29"		50033779	\$109.95

CARONI & CURTIS & SITREX

48" Model TC480N	2"	16 7/8"	3/4"	91140	\$ 59.95
60" Model TC590N Sitrex Model SM150	2"	20 1/4"	3/4"	91141	\$ 54.95
72" Model TC710N Sitrex Model SM180	2-1/2"	24-1/8"	3/4"	91142	\$ 59.95

CONTINENTAL BELTON - MUSTANG

Model	Wdt.	Len.	Hole Size	ORDER #	Price Set
MWR48 Rear & UnderMount	2"	16"	1/2"	KTR400	\$ 73.95
MWR60 Rear & UnderMount Replaces KTR291	2"	20"	1/2"	91452	\$ 79.95
MWR72 RearMount	2"	24"	1/2"	31259	\$ 84.95

FIRST CHOICE - PHOENIX - SICMA

Model	Width	Length	Hole Size	ORDER #	Price Set
48"	2-1/4"	16-3/8"	3/4"	BGM021	\$ 64.95
60"	2-7/16"	20"	3/4"	BGM022	\$ 74.95
72"	2-1/2"	24"	3/4"	BGM023	\$ 84.95
84"			3/4"	BGM041	\$ 109.95

KING KUTTER

Model	Wdt.	Len.	Hole Size	ORDER #	Price Set
60" Left Hand Cut	2"	20-1/16"	17/32"	91452	\$ 79.95
72" Left Hand Cut	2"	24"	17/32"	91453	\$ 89.95

KODIAK

Model	Wdt.	Len.	Hole Size	ORDER #	Price Set
48"				KFMB48	\$ 69.95
60"				KFMB60	\$ 79.95
72"		24"		KFMB72	\$ 94.95

*Finishing Mower Belts
Available for Kodiak and Many Other Mowers*



ORIGINAL LANDPRIDE

Model	Wdt.	Len.	Hole Size	ORDER #	Price Set
48" Hi - Suction	2 1/2"	16 7/8"	1"	890-219C	\$ 76.95
48" Lo-Suction	2 1/2"	16 7/8"	1"	890-323C	\$ 76.95
60" Hi - Suction	2 1/2"	20 3/4"	1"	890-171C	\$ 84.95
60" Low - Suction	2 1/2"	20 3/4"	1"	890-204C	\$ 109.95
72" Hi - Suction	2 1/2"	24 1/2"	1"	890-172C	\$ 99.95
72" Low - Suction	2 1/2"	24 1/2"	1"	890-200C	\$ 119.95
90" Hi - Suction	2 1/2"	31 1/2"	1"	890-223C	\$ 134.95
90" Low - Suction	2 1/2"	31 1/2"	1"	890-205C	\$ 149.95

NOTE: ALL Blades Are OEM. Blades Are 1/4" Thick EXCEPT For The 90" Mowers and The Low Suction Blades, They Are 5/16" Thick. The Low Suction Blades Are Used Primarily In Sandy Conditions.

REPLACEMENT LANDPRIDE

FITS: 60" Mowers,
(A High Suction Blade),
Replaces Landpride # 890-171C.
Set Of 3. Standard Blades
ORDER # 19LP457.....\$ 54.95



FITS: 60" Mowers
Set Of 3 Mulching Blades
ORDER # 91927.....\$ 59.95

FITS: 72" Mowers, (A High Suction Blade),
Replaces Landpride # 890-172C.
Set Of 3. Standard Blades
ORDER # 19LP456.....\$ 64.95

FITS: 72" Mowers
Set of 3 Mulching Blades
ORDER # 91928.....\$ 79.95



*IF YOU ARE WILLING AND OBEDIENT, YOU SHALL
EAT THE GOOD OF THE LAND.
— ISAIAH 1:19*

WOODS ORIGINAL BLADES REARMOUNT & BELLYMOWER

MODEL	WDT	LEN	HOLE SIZE	ROT	ORDER #	PRICE
42" CUT Belly & Rearmount	2-3/4"	19-1/2"	7/8"	CW	3975KT	\$ 84.95
42" CUT Belly & Rearmount	2-1/2"	19-1/2"	7/8"	CCW	3980KT	\$ 149.95
48" CUT RM400, RM- 48CO, JD, YM	1-3/4"	16-3/4"	5/8"	CCW	31348KT	\$ 79.95
60" CUT Models 59 Med. Suction	2"	20-1/8"	5/8"	CW	6950KT	\$ 89.95
L59's, RM59, RM500	2"	20-1/8"	5/8"	CCW	31359KT	\$ 86.95
RD6000					1001513KT	\$ 89.95
RM550					34615KT	\$ 103.95
72" CUT L306's, RM306, RM600 Med. Suction	2-1/2"	24"	1"	CCW	13404KT	\$ 105.95
RM372, RM600 Hi-Suction	2-1/2"	24"	5/8"	CW	15127KT	\$ 119.95
RM306, RM600			1/2"		31306KT	\$ 105.95
90" CUT RM90, P90, RM990, P990 Med. Suction Set of 6	2-1/2"	12-3/4"	13/16"	CCW	24590KT	\$ 167.95
17 Ft CUT 9204, Hi-Suction Set of 3 Set of 9	2-1/2"	24-1/2"	5/8"	CCW	38251KT 38251KT3	\$ 110.95 \$ 329.95

WOODS REPLACEMENT BLADES REARMOUNT & BELLYMOWER

MODEL	Wdt.	Len.	Hole Size	ROT.	ORDER #	Price
42" Belly & Rearmount	2-3/4"	19-1/2"	7/8"	CW	125-1504	\$ 64.95
42" Belly & Rearmount	2-1/2"	19-1/2"	7/8"	CCW	SEE OEM	\$ CALL
60" CUT Model 59'S - Med Suct.	2"	20-1/8"	5/8"	CW	6950	\$ 48.95
L59'S, RM59, RM500 Hi-Suction	2"	20-1/8"	5/8"	CCW	23825	\$ 49.95
RD6000, PRD6000					91584	\$ 42.95
72" CUT - Med Suction L306'S, RM306, RM600	2-1/2"	24"	1"	CCW	13404	\$ 55.95
RM372, RM600 High Suction	2-1/2"	24"	5/8"	CW	91766	\$ 69.95
90" CUT - Set Of 6 RM90, P90, RM990, P990 Med Suction. Set of 3	2-1/2"	12-3/4"	13/16"	CCW	91767K 91767	\$ 128.95 \$ 64.95

UNIVERSAL FINISHING MOWER PARTS

These Universal Finishing Mower Wheels Can Be Used On Many Mowers.

SOLID WHEELS



2-3/4" Width
8-1/4" OD
with 3/4" Axle Bore
ORDER # 814079C \$ 49.95

3-1/4" Width
10-1/4" OD
with 3/4" Axle Bore with bearings. (814-057C)
**ORDER # 814188C \$ 59.95

3" Width 10" OD
with 1" Axle Bore
**ORDER # BB14..... \$ 39.95
• NOTE: OD = Overall Diameter

REDUCER AXLE BUSHINGS

Reducer Axle Bushing
All Bushings Are 3/4" OD to 1/2" ID
Listed Are Various Lengths

LENGTH	ORDER #	PRICE
3 3/8"	827-012C	\$ 9.40
4 1/4"	310-025D	\$ 6.95
5 1/8"	310-328D	\$10.95
6 3/8"	827-056C	\$10.95



UNIVERSAL ADD-ON WHEEL KIT

For Mowers With Two Rear Wheels ONLY. Now You Can Add Two Front Wheels To Your Present Finishing Mower. With Four Wheels This Allows Your Mower To Mow Evenly Over your Ground - Thus Preventing Scalping. It Will Require Some Fabrication On Your Part, But Once Completed It Will Be Well Worth The Time And Effort.

**** Additional Freight Charges Apply.**

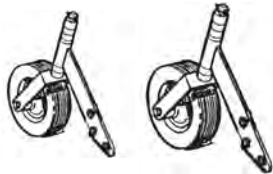

KIT Consists Of
(2) - (310-124H) Gauge Wheel Yokes
(4) - (827-002C) 1" Height Adjusting Spacers
(2) - (827-001C) 1/2" Height Adjusting Spacers
(2) - (814-079C) Tires
(2-3/4" Width X 8-1/4" OD), With Bearings.
(2) - (827-012C) Axle Bushings.
(2) - (310-123H) Heavy Duty Spindle Arms
(4) - (817-048C) Nylon Bushings.
(2) - (DKLP 1/4) 1/4" Lynch Pins.
Spindle Arms are Made Of Heavy Steel 1/2" Thick By 3" Wide By 16-1/2" Length With Predrilled Holes. 1/2" x 6-1/2" Axle Bolts Included.
**KIT ORDER # UWK \$ 439.95

BIG BEE

FINISHING MOWER PARTS

For Big Bee FM48, FM60, & FM72 Mowers



Spindle Cast Iron Pulley
ORDER # 44..... \$ Call

Idler Pulley (Metal)
ORDER # 45..... \$ 26.95



Spindle Assy Complete
ORDER # 5..... \$ 99.95



Large Pulley Under Gearbox
ORDER # 42..... \$ 69.95



Wheel Assy. - Rear 10.25" X 3.25"
**ORDER # BB14..... \$ 39.95

Tailwheel Fork
ORDER # 13..... \$ 41.95

Axle With Locking Nut
ORDER # 1000BN \$ 15.50

Spacer 1/2" Fits Tailwheel Fork
ORDER # 11..... \$ 2.50

Spacer 3/4" Fits Tailwheel Fork
ORDER # 12..... \$ 3.50



Kevlar Belt FITS: FM 48
ORDER # B96K \$ 31.95



Kevlar Belt FITS: FM60
ORDER # B108K \$ 33.95

Kevlar Belt FITS: RM72
ORDER # B128K \$ 39.95

Spring Idler Tension
ORDER # 27..... \$ 8.95

Blade Bolt LH Thread 1/2" x 1 1/4"
ORDER # KTR281 \$ 7.95



DriveLine For 5' Mowers
**ORDER # MDLFM..... \$ 139.95

CONTINENTAL BELTON

The Replacement Belts we carry are the Kevlar Blue V-Belts. They are an extra heavy duty belt constructed of organic polyamide fibers. The Kevlar belts have a high resistance to repeated reverse flexing, oil, heat and cracking. Kevlar belts also offer high tensile strength, non-extensibility, and high resistance to shock loads.

BLADE SPINDLE PARTS

Complete Assy. FITS: Undermount & Rear Mount Mowers - Greaseable Type.
ORDER # 33600 \$ 139.95



Blade Bolt (1/2 x 1 1/4 LH Thread)
ORDER # KTR281 \$ 7.95



FRONT ROLLER

Reduces Scalping; Easy to Install. Kit Comes Complete. Ready To Install, FITS: All Rear Mount & Under Mount Mowers.
ORDER # B1429 \$ 139.95

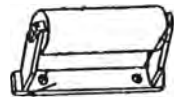

FIRST CHOICE PHOENIX - SICMA

Spindle Assembly, Less Pulley
FITS: 5Ft Mowers
ORDER # 5002725..... \$ 139.95

UNIVERSAL WHEEL HEIGHT SPACERS

Hole ID	Height	ORDER #	Price
1"	1/4"	BGM1000	\$ 1.50
1"	1/2"	BGM1001	\$ 1.50
1"	1"	BGM1002	\$ 2.00
1"	1-1/4"	BGM1003	\$ 2.00
1-1/4"	1/4"	BGM1004	\$ 2.00
1-1/4"	1/2"	BGM1005	\$ 2.00
1-1/4"	1"	BGM1006	\$ 2.50

LANDPRIDE FINISHING MOWER PARTS

WHEELS & PARTS

Wheels are priced each. The pictures show the front and side view only

Solid Tire

2-3/4" Width - 8-1/4" OD

With 3/4" Axle Bore,
Bushings NOT Included.
Used On The 48" Mowers.



ORDER # 814079C \$ 49.95

Solid Tire

3-1/4" Width - 10" OD

With 3/4" Axle Bore,
Used On The 60" Mowers.
Bushings NOT Included.



**ORDER # 814188C \$ 56.95

Bearing Kit

For The Above Wheels:

Consist Of: Two Outer Bushings 3/4" ID X 1-3/8" OD X 1" Long; (1) - Reducer Axle Bushing - 1/2" ID X 3/4" OD X 4-1/4" Long (1) - Axle Bolt With Nut - Size 1/2" X 6-1/2"

ORDER # LPWBK-ST \$ 17.95

Semi - Solid Tire

4" Width x 11" OD

5 Rib
With 3/4" Axle Bore,
Bushings NOT Included.



**ORDER # 814271C \$ 102.95

Pneumatic Tubeless Tire

4" Width x 10" OD,
With 3/4" Axle Bore Used
On The 60" & 72" Mowers.



ORDER # 814071C \$ 69.95

Tire Only — Size 4.10 X 350 X 4

ORDER # 341 \$ 17.95

Bearing Kit

For Pneumatic Tire ONLY: Consist Of

(1) - Bearing, (2) - Outer Retainers
(1) - Axle Bolt With Nut.

ORDER # LPWBK-PT \$ 19.95

SOLID TIRE CONVERSION

For Landpride Models FDR2560 thru 1660 & Models 2572 thru 1672

Tired of Flat Tires?

— Convert Your Air Tires To Solid Tires
And Never Worry About A Flat Again

Kit Consists of

(4) Solid Tires # 814-188C

(8) Spacers # 310329D

Use Your existing long spacer tubes and bolts. If you need the bolts and tubes the Bolts measure 1/2" x 6-1/2", and the tube # is 310-328D. NOT Included.

**ORDER # LPSTCK \$259.95

**Additional Shipping Charges Apply To This Item.

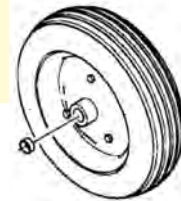

WHEEL BEARINGS & PARTS

FITS: Finish Mower Models:

AFM4011, AFM4014, AFM4016,
AFM40133, AFM40168, AFM40200,
AT2560, AT2572, AT3590, FD2560,
FD2572, FDR1560, FDR1572,
FDR3590; Replaces: 890-202C,
95316, 53-189, Tilden 53189



3/4" ID
1.35" OD
15/16"

Used on Land Pride Gauge wheels 814-071C, 814-117C, 814-070C, 814-114C, 814-188C and 814-053C, 814071C, 814117C, 814070C, 814114C, 814188C AND 814053C

ORDER # 95316 \$ 7.50

FITS: Finish Mower

Models: AFM4011, AFM4014,
AFM4016, AFM40133,
AFM40168, AFM40200,
AT2560, AT2572, AT3590,
FD2560, FD2572, FDR1560,
FDR1572, FDR3590;
Replaces: 890-202C, 95316,
53-189, Tilden 53189



3/4" ID
1-3/8" OD
3-1/2" Long

Used on Land Pride Gauge wheels 814-071C, 814-117C and 814-188C, 814071C, 814117C and 814188C.

Priced each. (1) used per wheel

ORDER # 95352NA \$ 10.95

OUTER WHEEL RETAINER

FITS: Finish Mower

Models: AFM series, AT series,
FD series, FDR series and most
all Land Pride Gauge wheels.

3/4" ID
1-3/8" OD
1/4" Long

Priced each. (2) used per wheel

ORDER # RT3414 \$ 2.25



WHEEL HEIGHT SPACER BUSHINGS

Spacer Bushings

Used for Wheel Height

1" Tall Bushing

ORDER # 827-002C \$ 4.95

1/2" Tall Bushing

ORDER # 827-001C \$ 3.95



SPINDLE BUSHING

FITS: Finish Mower Models:

AFM4011, AFM40133, AT2560,
AT2572, AT2584, AT2660,
AT2672, AT2684, FD1548,
FD1560, FD2548, FD2560,
FD2572, FDR1548, FDR1560, FDR1572,
FDR1648, FDR1660, FDR1672, FDR2548,
FDR2560, FDR2572, FDR2584; Replaces:
310-020S.



Plastic Spindle Bushing (8) used per Land
Pride Finish Mower.

ORDER # 817-048C \$ 2.25

TAILWHEEL FORK



Wheel Forks

Fork ONLY.

(Assembly Pictured)

FITS: FD1548,

FD1560, FDR1548

ORDER # 310-124H \$ 73.50

FITS: FD2560, FD2572, FDR1560, FDR1572,
FDR1648, FDR1660, FDR1672, FDR2548,
FDR2560, FDR2572.

Inside Width Measures 5-1/8" ID.

ORDER # 310-149H \$ 49.95

LANDPRIDE FINISHING MOWER PARTS

SPINDLES & PARTS

All Landpride Parts are Original Tan Color.
If you need the Kubota Orange, Please Specify before Ordering.

Complete Spindle & Pulley

Side Discharge Models
FITS: FD2548, FD2560, FD2572 With 5" Pulley
ORDER # 310-137S **\$139.95**

Complete Spindle & Pulley

Rear Discharge Models
FITS: FDR1548, FDR1648, FDR2548 & FDR1560, FDR1660, FDR2560.
With 5" Pulley
ORDER # 310-248S **\$139.95**



FITS: FDR1572, FDR1672 & FDR2572.
With 6" Pulley
ORDER # 310-249S **\$139.95**



Blade Bolts

FITS: All Side Discharge Models, that have not changed Spindle Shafts.
1/2" X 1-1/4"
ORDER # 802-384C **\$ 1.95**



FITS: All FDR Models & Side Discharge Models with New Style Spindle Shafts.
1/2" X 2"
ORDER # 802-695C **\$ 3.50**



Blade Washer

FITS: All Models
ORDER # 804-110C **\$ 10.95**

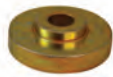

Spindle Bearings

FITS: All Models
ORDER # 822-006C **\$ 11.95**

SPINDLE ASSEMBLY

FITS: Finish Mower Models FDR3590, (AT3590 SN # 209358 & Up); Replaces: 310-250S
7-1/2" Pulley
ORDER # 310250S **\$179.95**



FITS: Finish Mower Models: AT3590 on the Right and Left Side of the mower, not for the center; Replaces: 310-097S
ORDER # 310097S **\$199.95**

FITS: Land Pride - Fits Finish Mower Models: FDR3690; Replaces: 310-435S
ORDER # 310435S **\$149.95**

SPRING TENSIONER

FITS: Finish Mower Models: AFM4011, AFM40133, AFM4014, AFM40168, AFM40169, AFM40200, AFM4211, AFM4214, AFM4216, AFM4522, AT2560, AT2572, AT2584, AT2660, AT2672, AT2684, (AT3590 up to SN # 209357), FD1548, FD1560, FD2548, FD2560, FD2572, FDR1548, FDR1560, FDR1572, FDR1648, FDR1660, FDR1672, FDR2548, FDR2560, FDR2572, FDR2584, FDR3690, RAZOR Z44, RAZORZ54, RAZOR ZSR54, RAZOR ZSR60, ZXT54, ZXT60; Replaces: 807068C, 807-068C
6-1/2" Overall Length
4-1/2" Coil Length
1-1/4" Coil OD
High Quality Spring Steel
Used to maintain correct belt tension
ORDER # 807068C **\$ 11.95**



FITS: Manual Retractable Box Scrapers: MR3566, MR3572, MR3578, MR3584, MRL3566, MRL3572, MRL3578;

FITS: Finish Mower Models: (AT3590 SN # 209358 & Up), FDR3590; Replaces: 807-050C, 807050C
1-13/32" X 6"
ORDER # 807050C **\$ 12.95**

BELTS FOR SIDE DISCHARGE MOWERS

NOTE: Original Belts are Black Kevlar.

FITS: 48" Mowers FD 1548 - 3-Spindles
Original ORDER # 816-142C **\$ 69.95**
Replacement ORDER # 816142CR... **\$ 30.95**

FITS: 48" Mowers FD2548 - 2-Spindles
ORDER # 816-074C **\$ 59.95**



FITS: FD1560 60" Mowers
Original ORDER # 816-116C..... **\$ 79.95**
Replacement ORDER # 816-116CR... **\$ 41.95**

FITS: FD2560 60" Mowers
Original ORDER # 816-063C **\$ 67.95**
Replacement ORDER # 816-063CR.. **\$ 47.95**

FITS: FD2572 72" Mowers
Original ORDER # 816-064C **\$ 65.95**
Replacement ORDER # 816-064CR.. **\$ 49.95**

BELTS FOR REAR DISCHARGE MOWERS

NOTE: Original & Replacement Belts Available

FITS: FDR1548, FDR1648, FDR2548 48" Mowers
Original ORDER # 816-142C **\$ 69.95**
Replacement ORDER # 816-142CR... **\$ 30.95**



FITS: FDR1660, FDR2560 60" Mowers
Original ORDER # 816-308C **\$ 79.95**
Replacement ORDER # 816-308CR... **\$ 34.95**

FITS: FDR1560 60" Mowers AND FDR2572, FDR1672 72" Mowers
Original ORDER # 816-116C..... **\$ 79.95**
Replacement ORDER # 816-116CR... **\$ 41.95**

FITS: FDR1572 72" Mowers
Original ORDER # 816-141C **\$ 96.95**
Replacement ORDER # 816-141CR... **\$ 54.95**

FITS: FDR2584 — 84" Mowers.
Replaces: 816-311C
Original ORDER # 816-064C **\$ 65.95**
Replacement ORDER # 816-064CR... **\$ 49.95**

FITS: FDR3590 90" Mowers (7/8" wide)
Original ORDER # 816-101C..... **\$119.95**
Replacement ORDER # 816-101CR... **\$ 51.95**

We pride ourselves in providing excellent customer service to our customers. Got a question? Call today and our friendly staff will be happy to assist you.

1-800-333-9143

WWW.STEVENSTRATOR.COM

LANDPRIDE FINISHING MOWER PARTS

IDLER PULLEY

FITS: Finish Mower Models: AFM4011, AFM40133, AFM4014, AFM40168, (AFM4211 with SN # 744354 & Up), AFM4214, AFM4216, (AT2560 up to SN # 72225), (AT2572 up to SN # 72225), **FD1548, FD1560, FD2548, FD2560, FD2572, FDR1548, FDR1560,** (FDR1648 SN # 744354 & Up), **ZST40, ZST48;** Replaces: 808-073C



Flat Idler Pulley
6-1/4" OD
5/8" ID

NOTE: Measure BEFORE Ordering

ORDER # 808073C \$ 49.95

FITS: Finish Mower Models: AFM4014, AFM4214, AFM40168, (AT2560 up to SN # 72225), (AT2572 up to SN # 72225), **FD2560, FD2572;** Replaces: 808-074C

V - Idler Pulley
5" OD

NOTE: Measure BEFORE Ordering

ORDER # 808074C \$ 53.95

FITS: AFM4011, AFM40133, AFM4014, AFM40168, AFM4211, AFM4214, AT2560, AT2572, AT2584, AT2660, AT2672, AT2684, FD1548, FD1560, FD2548, FD2560, FD2572, FDR1548, FDR1560, FDR1572, FDR1648, FDR1660, FDR1672, FDR2548, FDR2560, FDR2572, FDR2584, RAZOR Z44, RAZOR Z48, ZST48; Replaces: 808-075C



B-Groove Pulley 5" OD
Keyed
1" ID

NOTE: Measure BEFORE Ordering

ORDER # 808075C \$ 36.95

FITS: Finish Mower Models: AT2560, AT2572, AT2584, AT2660, AT2672, AT2684, FD2548, FD2560, FD2572, FDR2548, FDR2560, FDR2572, **FDR2584;** Replaces: 808-076C, 808076C, 808-333C, 808333C



B-Groove Pulley 9" OD

NOTE: Measure BEFORE Ordering

ORDER # 808076C \$ 69.95

FITS: Finish Mower Models: AT2560, AT2572, FD1560, **FD2560, FD2572;** Replaces: 808-077C, 808077C, 808-334C, 808334C



B-Groove Pulley
10" OD
Keyed
1-1/4" ID
Cast Iron

NOTE: Measure BEFORE Ordering

ORDER # 808077C \$ 61.95

FITS: Finish Mower Models: AFM4522, AT3590, FDR3590; Replaces: 808-107C, 808107C

Idler Pulley
9" OD

NOTE: Measure BEFORE Ordering

ORDER # 808107C \$ 98.95

FITS: Finish Mower Models: AFM4016, AFM40200, AT2560, AT2572, AT2584, AT2660, AT2672, AT2684, FD2560, FD2572, FDR1560, FDR1572, FDR1648, FDR1660, FDR1672, FDR2548, FDR2560, FDR2572, FDR2584, RAZOR ZSR54, RAZOR ZSR60, ZST40, ZXT54, ZXT60; Replaces: 808-127C, 808127C.



B-Groove Drive Pulley
6" OD
Keyed
1" OD

NOTE: Measure BEFORE Ordering

ORDER # 808127C \$ 44.95

FITS: Finish Mower Models: AFM4016, AFM4216, AFM40200, (AT2560 SN # 72226 & Up), (AT2572 SN # 72226 & Up), FDR1572; Replaces: 808-128C, 808128C.



B-Groove Drive Pulley
6-1/4" OD
5/8" ID

NOTE: Measure BEFORE Ordering

ORDER # 808128C \$ 50.95

FITS: Finish Mower Models: AFM4014, AFM40168, AFM4016, AFM40200, AFM4214, AFM4216, AT2560, AT2572, AT2584, AT2660, AT2672, AT2684, FD1548, FD1560, FDR1572, FDR1648, FDR1660, FDR1672, FDR2548, FDR2560, FDR2572, **FDR2854;** Replaces: 808-335C, 808335C.



B-Groove Pulley
11" OD
Keyed
1-1/4" ID
Cast Iron

NOTE: Measure BEFORE Ordering

ORDER # 808335C \$ 62.95

GEARBOXES

FITS: Finish Mower Models: AT2560, AT2572, FD1560, FD2548, FD2560, FD2572, (FDR2548, FDR2560, FDR2572, FDR2584; **Check Gearbox numbers BEFORE ordering);** Replaces: 826-325C, 826325C, 826203C, 826-203C.



50 HP Gearbox
Clockwise Rotation
1:2.5 Gear Ratio

NOTE: Check Gearbox Numbers BEFORE ordering.

ORDER # 826325C \$ 479.95

FITS: Finish Mower Models: AFM4011, AFM4014, AFM4016, AFM4211, AFM4214, AFM4216, AFM4522, AFM40133, AFM40168, AFM40200, AT2584, AT2660, AT2672, AT2684, AT3590, (FD1548, FDR1548, FDR1560, FDR1572, **check gearbox numbers BEFORE ordering), (FDR2548, FDR2560, FDR2572, FDR2584, check gearbox numbers BEFORE ordering), FDR3590, FDR3690;** Replaces: 826-326C, 826-204C, 826204C, 826326.



50 HP Gearbox
Clockwise Rotation
1:2.8 Gear Ratio

NOTE: Check Gearbox Numbers BEFORE ordering.

ORDER # 826326C \$ 479.95

WOODS REARMOUNT MOWER PARTS

BLADE BOLTS & PARTS

FITS: RM400, RM48, RM59, L59

(21) Shoulder Washer
ORDER # 4110..... \$ 21.95

(48) Flat Washer
Order a 5/8"
Flat Washer \$.25

(50) Cup Washer
ORDER # 10635..... \$ 1.95

(46) Bolt
Left Hand Thread
5/8" X 1 1/2"
ORDER # 10718 \$ 17.95

FITS: RM90

Blade Pin
ORDER # 3967..... \$ 13.95

Special Bolt
ORDER # 13288..... \$ 3.75

FITS: Models RM42, 42C-6

Locking Bolt
ORDER # 13288..... \$ 3.75

Blade Pin
ORDER # 3967..... \$ 13.95

Retainer
ORDER # 25869..... \$ 3.75

FITS: RM306-2 & 306-3

(44) Bolt Left
Hand Thread.
5/8" X 2 3/8"
ORDER # 24184..... \$ 17.50

(46) Flat Washer -
Heat Treated
ORDER # 13451..... \$ 6.95

(52) Cup Washer
ORDER # 13401..... \$ 5.50

(51) Flat Washer
ORDER # 13405..... \$ 2.25

*He only is my rock and my
salvation: he is my defense;
I shall not be moved.
— Psalm 62:6*

SIDE SKIDS

FITS: RM48
ORDER # 31368..... \$ 39.95

FITS: RM42, RM48CO,
RM48JD, RM48YM,
RM48KB, RM48WH,
RM59CO, RM59K,
RM595B, RM59LB.

FITS: UnderMount Mowers
59CL4, 42C-6, 59HC, 59C2,
L59, L306
L-Shaped Skids
RH | ORDER # 4141 \$ 84.95
LH | ORDER # 4142 \$ 84.95

FITS: RM59-1,
RM59-2, RM59-3
RH & LH Side
ORDER # 31315..... \$ 41.95

FITS: RM306-3
RH & LH Side
ORDER # 31665..... \$ 39.95

WHEEL PARTS

Ref 53
Sleeve
1/2 x 3/4 x 3 3/8
ORDER# 29368..... \$ 6.95

Ref 74
Bushing
ORDER# 29375 \$ 5.50

Ref 23
Bearing
ORDER # 34466..... \$ 18.50

Ref 24
3-1/2" Wide X 8" OD
Original Woods Wheel Kit
Includes - Wheel,
Bushing & Sleeve.
(Wheel Bolt Not Included)
ORDER # 19703..... \$ 83.95

NOTE: Optional
Larger Wheel Available
3-1/4" Wide X 10" OD
Replacement
**ORDER # 814188C \$ 56.95

REARMOUNT BELTS

*Original (Black Belt) &
Replacement (Blue Belt)
Available.*



FITS: Model RM42
61-1/16" Long
Original ORDER # 26355 \$ 37.95
Replacement ORDER # B58K..... \$ 19.95

FITS: Model
RM400-3 SN 5000 Up
Original ORDER # 29010 \$ 79.95
Replacement ORDER # 29010R... \$ 25.95

FITS: Model RM48
127-7/8" Long
Original ORDER # 26840 \$105.95
Replacement ORDER # 26840R... \$ 42.95

FITS: Model
RM59-CO Series,
RM660, & RD7200
133-11/16" Long
Replaces OEM # 24004
Original ORDER # 18879 \$ 86.95
Replacement ORDER # 18879R... \$ 47.95

FITS: Model
RM59-1, RM59-2, RM360
182-1/16" Long
Original ORDER # 31700 \$114.95
Replacement ORDER # 31700R... \$ 57.95

FITS: Models RM59-3 SN# 7500 -Up
152-1/4" Long
Original ORDER # 33652 \$ 98.95
Replacement ORDER # 33652R... \$ 49.95

FITS: Model RM306-2
220" Long
Original ORDER # 31666 \$140.95
Replacement ORDER # 31666R... \$ 65.95

FITS: Model
RM306-3 SN# 25000 Up, RM306-8
176-3/4" Long
Original ORDER # 33710 \$132.95
Replacement ORDER # 33710R... \$ 59.95

FITS: Models
RM90-1 & RM90-2
Original ORDER # 29344 \$316.95
Replacement ORDER # 29344R... \$144.95

FITS: RM500
Original ORDER # 28975 \$ 81.95
Replacement ORDER # 28975R... \$ 35.95

FITS: Models RM550,
RDC54, RD60, RD72
Original ORDER # 20644 \$ 86.95
Replacement ORDER # 20644R... \$ 37.95

WOODS UNDER MOUNT MOWERS

UNDER MOUNT 42" MOWER PARTS

For Farmall Cubs with Models 42" UnderMount Mowers

OverRunning Clutches
3179 & # 3326

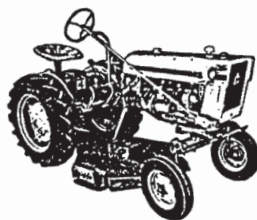

- (2) Oil Seal
ORDER # 3174 \$ 18.95
- (3) 3/8" NC x 1 Bolt
ORDER # 839 \$.25
- (4) 3/8 Lock Washer \$.05
- (5) Ratchet Cap
(Includes 2 & 6 Installed)
ORDER # 3333 \$109.95
- (6) Bushing
ORDER # 3175 \$ 23.95
- (7) Ratchet
With Hex Hole
ORDER # 3171 \$ 88.95
- (8) Compression Spring
ORDER # 3176 \$ 7.95
- (9) Drive Hex
ORDER # 3177 \$179.95
- (10) 1 3/4 x 3 3/8 x 18 GA. Flat Washer
ORDER # 3178 \$ 5.95
- (11) .070 x 3 1/2 X 5 Gasket
ORDER # 6935 \$ 7.95
- (12) Sheave
(Includes 2 & 6 Installed)
ORDER # 3332 \$439.95
- (13) Key ORDER # 3912..... \$ 4.50
- (14) 3/8 NC x 1-1/4 Bolt..... \$.30
- (15) Weather Cap
ORDER # 3172 \$ 10.95
- (16) 3/8 Flat Washer \$.10
- (17) Pulley, Idler
5/8" ID & 7-5/16" OD.
2 Required.
ORDER # 4072 \$ 42.95
- (18) Pulley,
Drive Cast Iron
ORDER # 1505 \$ 96.95

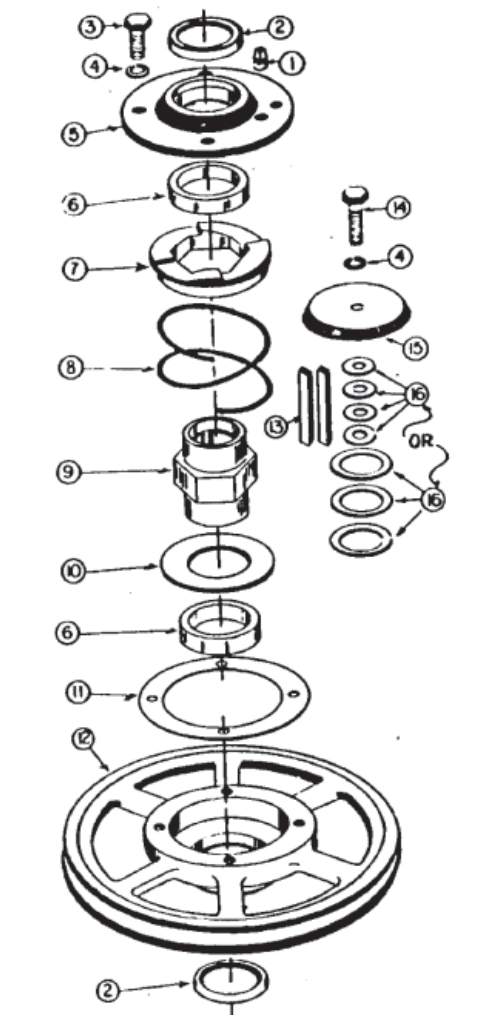

- (19) Hub, 10 Spline
With Bolts.
ORDER# 1506 \$ 34.95
- (20) Blade
Locking Bolt.
ORDER # 13288 \$ 3.75
- (21) Blade
Pin Retainer
ORDER # 25869 \$ 3.75
- (22) Blade Pin
ORDER # 3967 \$ 13.95

WOODS UNDER MOUNT MOWER PARTS

FITS: Models L59, A-3, L306-A Cutters.

(Ref 14)
Drive Pulley
9-3/4" OD
ORDER # 1481 \$229.95

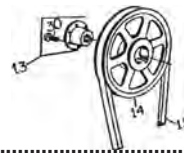

(Ref 13)
Bushing
1-1/8" - 6 Spline
ORDER # 3651 \$ 51.95



(Ref 13)
Bushing
1-3/8" - 6 Spline
ORDER # 4001 \$ 59.95



(Ref 7)
Idler Pulley
With Bearing 4-1/2" OD
ORDER # 4336..... \$ 71.95



(Ref 9)
Bearing Only
ORDER # 6095 \$ 27.95

UNDER MOUNT MOWER BELTS

Models: 42C-1, 2, 3, 4,
Mostly Found On Cub Tractors
135-9/16" Long
Original ORDER # 1469 \$ 71.95
Replacement ORDER # 1469R..... \$ 30.95



Models: 42C-5
139-5/16" Long
Original ORDER # 3546 \$ 82.95
Replacement ORDER # 3546R..... \$ 41.95

Models: 42C-6
139-15/16" Long
Original ORDER # 27652 \$ 87.95
Replacement ORDER # 27652R.... \$ 32.95

For Super A, 100,
130, & 140 that use a
42" Mower Model L59A-3
213-3/8" Long
Original ORDER # 4152 \$112.95
Replacement ORDER # 4152R..... \$ 49.95

For Mower Models L59GM4,
L59JD95, L306B27,
L306H254, H255 & H284.
233-1/2" Long
Original ORDER # 23990 \$139.95
Replacement ORDER # 23990R.... \$ 57.95

WHEEL RAKE ASSEMBLIES

6.5 MM COMPLETE WHEEL RAKE ASSEMBLY

Wheel Rake *FITS*: **Gehl, John Deere, OTMA, Rossi, Sitrex, Tonutti, Vermeer and Vicon.**
 The Complete Wheel Rake **Does NOT** Include the hub or bearings. This Wheel Rake is Already Assembled. The tines measure 6.5mm thick (127-1211 Replacement Tine).
This item MUST SHIP by Freight Truck - Additional Freight Charges Apply



Right Hand Side (Uses 127-121 Tine)
ORDER # P20BG001\$129.95

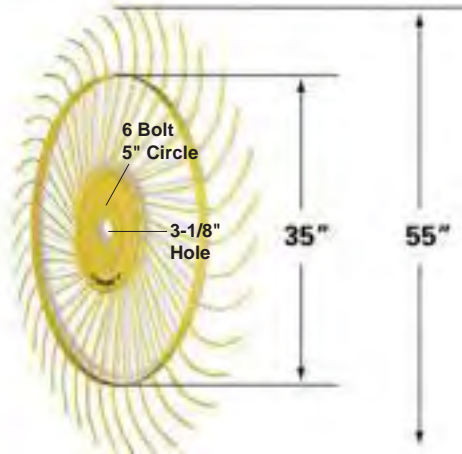

Left Hand Side (Uses 127-211 Tine)
ORDER # P20BG002 \$ 129.95

TINE CLIP

WHILE SUPPLIES LAST!

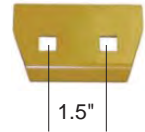

Tine Clip For **Tonutti & Vicon Wheel Rakes** Measures 1.5" Center to Center Mounting Holes
ORDER # 90092672..\$ 3.95

FITS: Sitrex Wheel Rakes Measures 1.5" Center to Center
ORDER # 200012.....\$ 6.95

7 MM COMPLETE WHEEL RAKE ASSEMBLY

Frontier Wheel Rakes -
FITS: **WR1108, WR1112, WR116, WR1212C, WR1214C, WR1216C, WR1218C, WR3008, WR3010, WR3012, WR3310, WR3312, WR3313, WR3315;**

FITS: **Gehl, H&S, John Deere** (702 & 704; Replaces: HPBFR31), **OTMA, Rossi, Sitrex, Tonutti** (RTP10, RTP12, RTP8, V10, V12, V14, V16, V18, V20; Replaces: TEP20BG003) **and Vermeer.** The Complete Wheel Rake **Does NOT** include the hub or bearings. This Wheel Rake is Already Assembled.
This item MUST SHIP by Freight Truck Additional Freight Charges Apply

RH Wheel Rake
 55" Diameter
 7mm Straight Tines
 (6) 12.5mm Bolt Holes on a 131mm (5") Bolt Circle
 80mm (3-1/8") Pilot Hole
 No Center Hub Included
 Uses Replacement Tine # E95724
 This Wheel Rake Assembly **Must Ship Freight Truck**

ORDER # P20BG003\$119.95



Frontier Wheel Rakes -
FITS: **WR1108, WR1112, WR116, WR1212C, WR1214C, WR1216C, WR1218C, WR3008, WR3010, WR3012, WR3310, WR3312, WR3313, WR3315;**

FITS: **Gehl, John Deere** (702 & 704; Replaces: HPT174), **OTMA, Rossi, Sitrex, Tonutti** (RTP10, RTP12, RTP8, V10, V12, V14, V16, V18, V20; Replaces: TEP20BG004) **and Vermeer.** The Complete Wheel Rake **Does NOT** include the hub or bearings. This Wheel Rake is Already Assembled.
This item MUST SHIP by Freight Truck Additional Freight Charges Apply

LH Wheel Rake
 55" Diameter
 7mm Straight Tines
 (6) 12.5mm Bolt Holes on a 131mm (5") Bolt Circle
 80mm (3-1/8") Pilot Hole
 No Center Hub Included
 Uses Replacement Tine # E95724
 This Wheel Rake Assembly **Must Ship Freight Truck**

ORDER # P20BG004\$119.95



MASSEY FERGUSON VICON - LELY



Rake Teeth

Replaces OEM # 92611

ORDER # 1271213..... \$ 1.75 ea.

BUY MORE, SAVE MORE - 50 or More... \$ 1.50 ea.

MASSEY FERGUSON VICON - LELY & VERMEER

Used on P20BG001 & P20BG002 Rakes.



FITS: VERMEER WR20A, 22A, 24A

Vermeer OEM # 115663-001

Vicon OEM # 36133

NEW HOLLAND

FITS: 55, 56, 57, 256, 258, 259, 260.

and many more Rakes

6.5 mm Tine.

ORDER # 1271211..... \$ 1.75 ea.

BUY MORE, SAVE MORE - 50 or More... \$ 1.50 ea.

TONUTTI & ROSSI

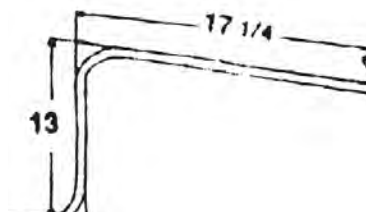

Rake Teeth -

Right Hand

Original Mfg. # PRO15

ORDER # 1271278..... \$ 1.85 ea.

BUY MORE, SAVE MORE - 40 or More... \$ 1.60 ea.

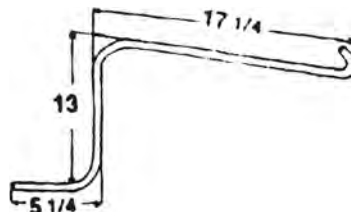

Rake Teeth -

Left Hand

Original Mfg. # PLO15

ORDER # 1271279..... \$ 1.85 ea.

BUY MORE, SAVE MORE - 40 or More... \$ 1.60 ea.

OTMA - SITREX - SAMA ATLAS GUAPO HINES



Rake Teeth

Replaces ORDER # OT1

ORDER # 1271253..... \$ 1.75 ea.

BUY MORE, SAVE MORE - 50 or More... \$ 1.50 ea.

JOHN DEERE & TONUTTI

Used on P20BG003 & P20BG004 Rakes.

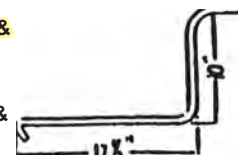

**Also For Millennium & Dominator Rakes
Right or Left**

John Deere Model 702 (8&10 Wheel);

Model 704 (10, 12, 14 Wheel)

Tonutti Models T13, V10 - V20

Heavy Duty 7mm Tine (Black)

ORDER # E95724..... \$ 1.95 ea.

ROSSI

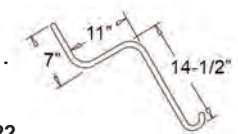

6.5mm

FITS: Rake Model 2222.

ORDER # 1271216..... \$ 1.95

RUBBER TEETH

NEW HOLLAND & MASSEY FERGUSON (LH)

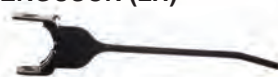

FITS: New Holland - Rolobar Rake Models:

56B, 256, 258, 259, 260; Replaces: 850613,

NH850613, 600001, 65668. Massey

Ferguson - Rake Models: 25, 36, 37.

ORDER # 1271302..... \$ 4.60

NEW HOLLAND & MASSEY FERGUSON (RH)



FITS: New Holland - Rolobar Rake Models:

56B, 256, 258, 259, 260; Replaces: 850614,

NH850614, 600002, 139041, 300213; Massey

Ferguson - Rake Models: 25, 36, 37.

ORDER # 1271303..... \$ 4.60

UNIVERSAL (IMPORT)



FITS: Allis Chalmers; Replaces: 70544034,

70544034V. John Deere: 350, 640, 650,

652, 660, 662, 670, 672, 858A, 894A, 896;

Replaces: PM3000-700. New Holland: 56, 57,

256 (3/8" hole and slot); Replaces: 65609,

65609NH, 850612. New Idea.

ORDER # 1271301..... \$ 2.95

JOHN DEERE



FITS: Twin Rake Models 700 & 705

ORDER # 1271307..... \$ 3.50

JOHN DEERE (UNIVERSAL)



FITS: Rake Models: 54, 64, 74, 650, 652, 660,

662, 670, 672; Replaces: 96R4, AE47389,

AE24953, 600004.

ORDER # 1271306..... \$ 3.50

Bag of 10

ORDER # 127130110..... \$ 25.00

VERMEER & MASSEY FERGUSON

FITS: Vermeer - Round

Baler Models: 503I,

504H, 504I, 504 Super

I, 504I Silage, 504L,

505I, 505 Super I, 505L, 554XL, 555XL, 604J,

604K, 604XL, 605H, 605J, 605 Super J, 605K,

605L, 605XL, 5400 Rebel, 5410 Rebel, 5500.

Rebel Massey Ferguson - Round Baler

Models: 1440, 1455, 1550, 1565.

ORDER # 1271304..... \$ 6.50

INTERNATIONAL

CLOSEOUT

FITS: Rake Models # 9, 14, 16.

ORDER # 1271305..... \$ 7.95



TEDDER TINES

DEUTZ - FAHR

FITS: KH2.36DN,
KH2.44DN,
KH2.52DN
ORDER # FA06580456Z



\$ 9.95

GALFRE

FITS: Hay Rake Models: 280,
GT280, GTS280.
ORDER # 10370000..... \$ 13.95

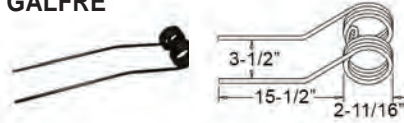

KUHN

FITS: GF22NP, GF22NT,
GF3701, GF4201MH, GF440SRP, GF440T,
GF5000MH, GF5000T, GF50001, GF6000,
GF6000MH, GF6301, GF6301MH, GF7000T,
GF7001, GF7001T, GRS21, GRS24.
ORDER # 1271264..... \$ 10.95



KUHN - NEW HOLLAND

KUHN
FITS: 23N, GF440S, GF440,
GF440M, GF440P, GF440T,
GF452M, GF452P,
GF452T, GF671 and Disc Mower Model SRP.
NEW HOLLAND
FITS: 156, 158, (162 Early models).
ORDER # 1271265..... \$ 10.95

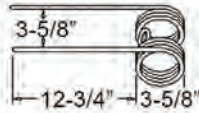

KUHN

FITS: GF22SP, GF23, GF4, GF4SP,
GF440, GF440P, GF440T, GF452M,
GF452P, GF452T.
ORDER # 1271266..... \$ 10.95



QUESTIONS?
Give us a call at 1-800-333-9143

SITREX, Tonutti, Agris & Others

FITS: Many Models.
ORDER # 200401..... \$ 10.95

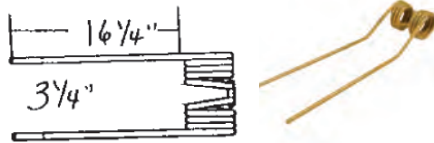

PZ

CLOSEOUT
FITS: PZ Model DS5000
Four Basket Rake Tedder
Narrow (Painted Yellow)
ORDER # PZ190..... \$ 13.95



PZ-ZWEEGERS

FITS: HS360, Haybob 300, Hay
Bob 300; Two Basket Rake
Tedder; (RH Side; Narrow Tine)
ORDER # PZ224..... \$ 11.95



PZ-ZWEEGERS

FITS: HS360, Haybob 300, Hay
Bob 300; Two Basket Rake
Tedder; (LH Side; Narrow Tine)
ORDER # PZ107..... \$ 9.95



PZ-ZWEEGERS

FITS: HS360,
Haybob 300, Hay Bob 300; Two Basket
Rake Tedder; (LH Side; Wide Tine)
ORDER # PZ110..... \$ 9.95



PZ-ZWEEGERS

FITS: HS360, Haybob 300,
Hay Bob 300; Two Basket Rake
Tedder; (RH Side; Wide Tine).
ORDER # PZ225..... \$ 11.95



NIEMEYER (LH)

FITS: HR301, HR361, HR362, HR401,
HR460.11, HR462, HR501, HR562, HR621,
HR702, HR751.
ORDER # 600039..... \$ 11.95

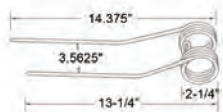

NIEMEYER (RH)

FITS: HR301, HR361, HR362, HR401,
HR460.11, HR462, HR501, HR562, HR621,
HR702, HR751.
ORDER # 600038..... \$ 13.95



ZWEEGER

FITS: 400, 500,
Fanex 400, Fanex 500,
Fanex 600, Fanex 641, Fanex 730; (1987 &
up for the Fanex models).
LH | ORDER # PZ339..... \$ 9.95
RH | ORDER # PZ340..... \$ 9.95



Nothing in all creation is hidden from God's sight. Everything is uncovered and laid bare before the eyes of Him to whom we must give account.

— Hebrews 4:13

ALLIS CHALMERS

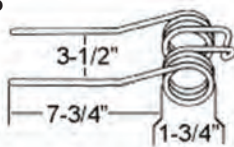

FITS: 71951 & Up
 ORDER # 511506..... \$ 4.95

CASE

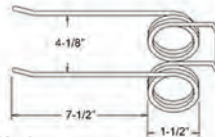

FITS: 169, (170 & F170, 1939 & Up)
 ORDER # R740S..... \$ 3.95

CASE

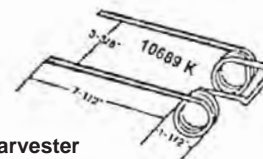

FITS: Forage Harvester Model 100 California.
 ORDER # 10689K..... \$ 4.95

FARMHAND (RH)

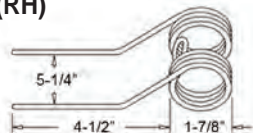

FITS: F-76, LR-5, LR-6, M3P, M-5, M-6.
 ORDER # 127-1204RH \$ 3.95

FARMHAND (LH)

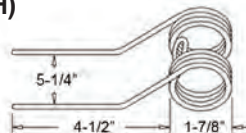

FITS: 76, LR-5, LR-6, M3P, M-5, M-6.
 ORDER # 127-1204 \$ 4.95

FORD

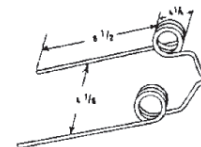

FITS: Rakes: 14-72, 503 Series (146545)
 ORDER # 1271208..... \$ 3.95

FORD - NEW HOLLAND

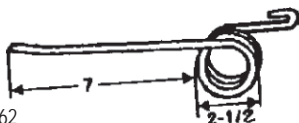

Replaces 64562
 FITS: 55, 56, 57, 256, 258, 259, 260.
 ORDER # 1271209..... \$ 1.75

FORD - NEW HOLLAND

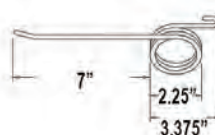

FITS: 55 (prior to 1951).
 ORDER # 40917..... \$ 2.60

FORD

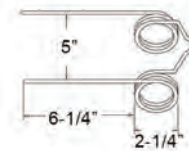

FITS: 503
 ORDER # 146545..... \$ 3.95

GEHL - CASE IH - HESSTON

GEHL
 FITS: Rake Model 2130, 2160.
 CASE IH & HESSTON
 FITS: Mower Conditioner Models: 1012, 8330, PT7, PT10, PT12; Swather / Windrower Models: 420, 620, 1014, 1070, 1090, 6600;
 ORDER # 611181 \$ 4.95

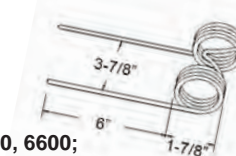

INTERNATIONAL HARVESTER

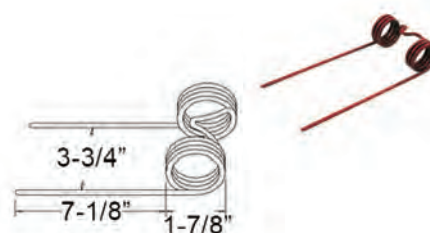

FITS: Mower Conditioner Models: 990, 1190, 1490, 1590,
 ORDER # 540565R1 \$ 5.25

INTERNATIONAL HARVESTER

Replaces 462978R1
 FITS: 3, 4, 5, 8, 9, 11, 14, 15, 16, 30, 35, 86, 96, 97.
 ORDER # 1271210..... \$ 1.95

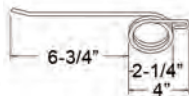

INTERNATIONAL

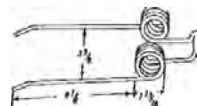

FITS: Rake Model #5 1952 & Up.
 ORDER # 455165R1 \$ 5.40

JOHN DEERE



FITS: Rake Models: 350, 851, 858, 894, 896.
 ORDER # 1271201..... \$ 2.10

JOHN DEERE

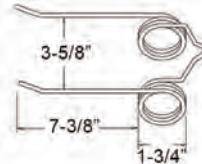

FITS: Double Rake Models: 596, 597, 714.
 ORDER # 237SE..... \$ 4.25

MASSEY FERGUSON

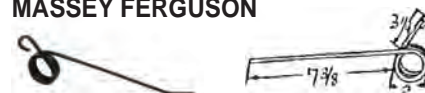

FITS: Rake All to 1957 DEO, MF20 Thru SN 1449.
 ORDER # 667656M1..... \$ 2.25

MASSEY FERGUSON

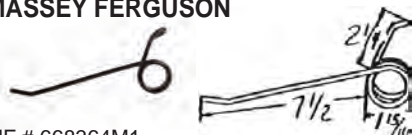

MF # 668364M1
 FITS: Rake Model 36 Pull Type Side Delivery, MF20, 25, MF37.
 ORDER # 1271205..... \$ 2.15

POLLARD



FITS: All Left Hand Models.
 ORDER # 1271203..... \$ 2.95

RAKE TOOTH HOLDER

Uses 3/8" CHB - not included
 FITS: All rakes with Steel Coil Teeth from Model 55 to Current Production.
 ORDER # 792493..... \$ 1.00



BALER / WINDROWER TEETH

FORD

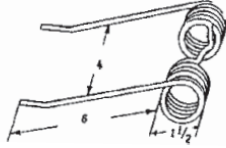

FITS: Square Baler Models: 150, 250, 350, 504, 506, 509, 520, 530, 532, 540, 542; Replaces: 96FC1, 600400.
ORDER # 149956..... \$ 5.95

FORD



FITS: Early 250 Balers, 504 Series, 1963 & Up.
ORDER # 147535..... \$ 4.15

HESSTON

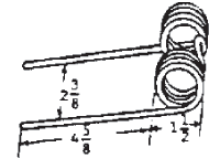

FITS: Round Baler Models 5600, 5800; Forage Harvester Models: 680, 684; Replaces: 96HE1, 600413.
ORDER # 7751621..... \$ 3.85

HESSTON



FITS: Baler Models: 530, 555S, 555T, 565A, 565T, 856A, 956A, 4460, 4650, 4760, 4800, 5400, 5510, 5530, 5540, 5545, 5585, 5600, 5800, 7433, 7434, 7444; Replaces: 2700222, 1710102, 01710102, 96HE6, 600416.
ORDER # 127-1225 \$ 2.95

HESSTON (ROUNDBALER)

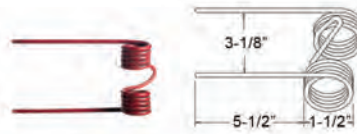

FITS: Hesston - Fits Round Baler Model: 5510; Replaces: HE4, 600418.
ORDER # 1711951..... \$ 4.50

INTERNATIONAL



FITS: Round Baler Models: 241, 2400; Square Baler Models: 428, 430, 435, 440, 445, 5420; Replaces: 600422
ORDER # 210614C1..... \$ 3.50

INTERNATIONAL HARVESTER

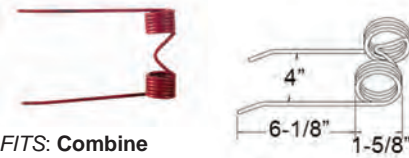

FITS: Combine Models: 122, 123, 125, 127, 141, 151, 161; Hay Balers: 45, 45T, 46, 55T, 55W, 435, 445.
ORDER # MA74528..... \$ 3.50

INTERNATIONAL HARVESTER



FITS: Round Baler Models: 241, 2400; Square Baler Models: 428, 430, 435, 440, 445, 5420; Replaces: 600422
ORDER # 210614C1..... \$ 3.50

IHC

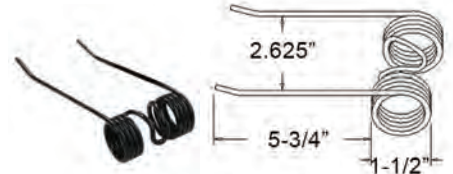

FITS: Round Baler Models: 3440, 3450, 3650; Replaces: ZA103012, ZA106550
ORDER # 103012..... \$ 3.50

JOHN DEERE

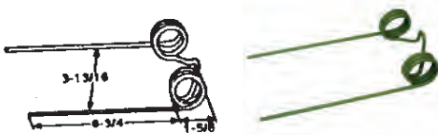

FITS: Square Baler Models: 14T, 24T, 214T, 214WS; Replaces: 276SE
ORDER # 1271202..... \$ 2.50

JOHN DEERE

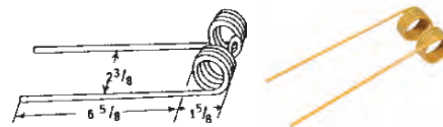

FITS: John Deere - Fits Square Baler Models: 327, 336, 337, 346, 347, 467; Replaces: E41833, 600430.
ORDER # 1271206..... \$ 2.25

JOHN DEERE

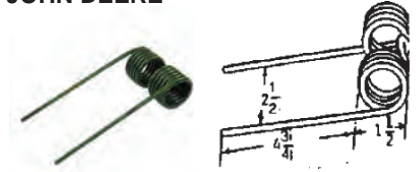

FITS: Round Baler Models: 330, 335, 340, 375, 430, 435, 530, 535; Replaces: E74678.
ORDER # 1271270..... \$ 2.60

JOHN DEERE

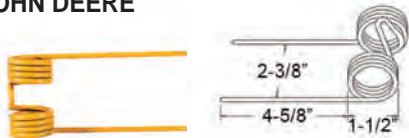

FITS: Round Baler Models: 410, (430 up to SN # 710000), 500, 510, (530 up to SN # 710000); Replaces: JD1D, 600429, E61295, E67036
ORDER # 1271214..... \$ 2.50

JOHN DEERE

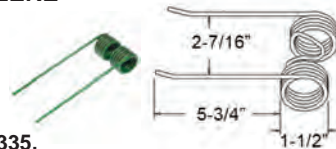

FITS: 430, 530, 330, 335, 375, 435, 535, 385, 466, 566, 446, 546, 456, 556, 469, 567, 457, 557, 448, 449, 547, 458, 558, 449, 459, 559, 569; Replaces: E79475.
ORDER # E79475..... \$ 2.70

JOHN DEERE

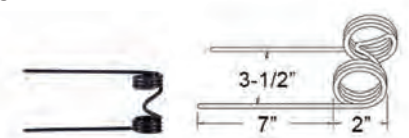

FITS: Cutting Platform Head Models: 230, 240; Mower Conditioner Models: 710, 720, 820, 1207, 1209, 1217, 1219, 1380, 1424.
ORDER # E68906..... \$ 3.25

MASSEY FERGUSON



FITS: Round Baler Models: 1560, 1655;
 Replaces: 1053394M1, 600440.
ORDER # 1271212..... \$ 3.25

MASSEY FERGUSON

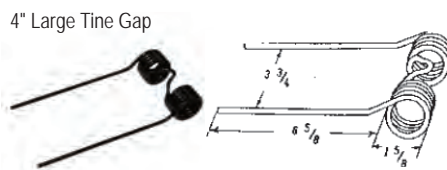

FITS: Square Baler Models: 3, 9, 10, 12; all up to 1958;
 Replaces: 600441.
ORDER # 665929M1..... \$ 3.95

MASSEY FERGUSON

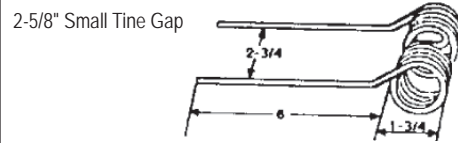

FITS: Square Baler Models: 3, 9, 10, 12; all up to 1958;
 Replaces: 665930M1, 151075M2, 600442.
ORDER # 665930M1..... \$ 4.50

MASSEY FERGUSON



FITS: Round Baler Models: 1440, 1455, 1550, 1565;
 Replaces: 1059176M1, 600005, 600018, 8000888, 300619.
ORDER # 1271304..... \$ 6.50

NEW HOLLAND

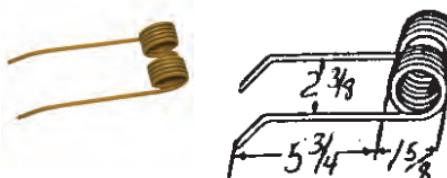

FITS: Various Bale Wagon Models, Various Forage Harvester Models, and Various Square Baler Models.
ORDER # 1271207..... \$ 2.50

NEW HOLLAND

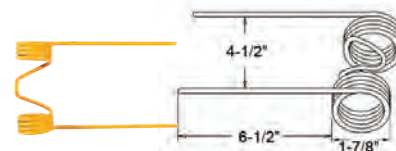

FITS: Haybine (Mower Conditioner) Models: 460, 461, 467, 472, 474, 488, 492, Windrower Models: 903, 907, 909, 912, 1100, 1112, 1114, (Self Propelled 1118);
 Replaces: 76517, 600230.
ORDER # 1271218..... \$ 3.30

NEW HOLLAND

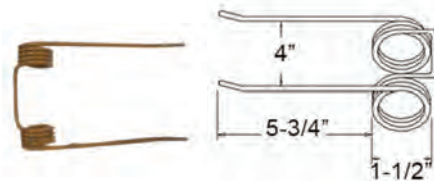

FITS: Square Baler Models: 67, Super 68, 69, 78, 268, 269, 270, 273;
 Replaces: 127566, 37762, NH1B, 600452.
ORDER # 127566..... \$ 2.40

NEW HOLLAND



FITS: Square Baler Model: 2000; Round Baler Models: (848 with Standard Pickup up to SN # 714628), 849, (853 with Standard Pickup up to SN # 724164), (855 up to SN # 733139);
 Replaces: NH1, NH1D1.
ORDER # 683310..... \$ 3.25

NEW HOLLAND

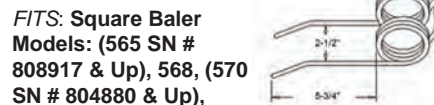

FITS: Square Baler Models: (565 SN # 808917 & Up), 568, (570 SN # 804880 & Up), (575 SN # 808665 & Up), 580;
 Replaces: 788853, NH1D2, 600456;
Round Baler Models: (848 with Standard Pickup SN # 714629 & Up), (853 with Standard Pickup SN # 724165 & Up), (855 SN # 733140 & Up);
 Replaces: 86595844, 86641710; **Windrower Inverters 144 and 166.**
ORDER # 788853..... \$ 3.05

NEW HOLLAND



FITS: Square Baler Models: 555, 565, 571, 571W.
ORDER # 210614C1..... \$ 3.50

NEW IDEA



FITS: Round Baler Models: 55, 465, 483, 484, 485, 486;
 Replaces: 600461, 6473-47353, 96NI3, 103012, 106550.
ORDER # 103012..... \$ 3.50

VERMEER

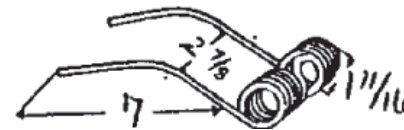

FITS: Round Baler Models: 403F, 403G, 504F, 605E, 605F, 605G;
 Replaces: 4059-001, 4059001.
ORDER # 1271212..... \$ 3.25

STONE - ROCK GUARDS

KUHN

Stone Guard

(1 Per Machine)

FITS: (GMD44 up to SN # 784791),

(GMD55 up to SN # 780100),

(GMD66 up to SN # 760500);

Replaces Kuhn # 561.905.00

ORDER # K56190500SZ \$ 89.95



**KUHN -
JOHN DEERE &
NEW HOLLAND**

All Guards Except first inner end guard.

FITS: KUHN's 44, 55, 66, 77HD.

Replaces Kuhn # 561-906-00.

FITS: John Deere Models 240 & 260

Replaces JD OEM # EB56190600

FITS: New Holland Models 442, 452,
462, 463, 462

ORDER # 1266601..... \$ 89.95



KUHN

Stone Guard

FITS: GMD500

SN 920001-950200;

GMD600 SN 940001-960530;

GMD700 SN 940001-960530.

(6) Required for GMD 600

and (7) are required for GMD700.

Priced Each.

ORDER # 56801420..... \$ 84.95



Can't Find Your Part?

Give us a call at

1-800-333-9143

or go online at

WWW.STEVENSTRATOR.COM

SKID PLATES

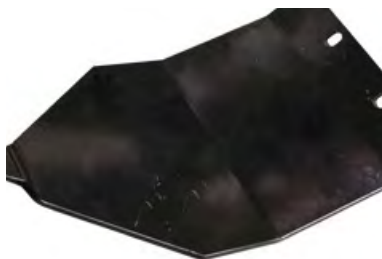

BUSHHOG:

FITS: Disc Mower

Models: DM70, DM80, DM90;

Replaces: 87724BH, 87724.

ORDER # BH87724Z \$ 43.95



BUSHHOG:

FITS: Disc Mower

Models: DM7, DM8, DM9;

Replaces: 86110, 76N875

CASE/IH:

FITS: Mower

Conditioner Model 3309;

Replaces: ZA526875

HESSTON:

FITS: Disc Mower

Models: 1004, 1005, 1006, 1007, 1008;

MASSEY FERGUSON:

FITS: Disc Mower

Models: 1306, 1307, 1308, 1309, 1310;

NEW IDEA:

FITS: Disc Mower

Models: 5209, 5212, 5312,

5406, 5407, 5408, 5409;

Replaces: 526875

ORDER # N526875SZ \$ 15.95



CASE IH:

FITS: Disc

Mower Models:

3204, 3205, 3206;

Replaces: ZA526438

NEW IDEA: FITS: Disc Mower

Models: 526, 527, 528; all prior to 1989;

Replaces: 526438

ORDER # ZA526438..... \$ 17.95

**KUHN,
JOHN DEERE
& NEW HOLLAND**



FITS: Disc Mower Models:

GMD55, GMD55HD, GMD66, GMD66HD,

GMD77, GMD77HD; Replaces: 563.302.00,

563-302-00, 56330200, RW302.

Weld - On Skid Plate

ORDER # 1266608..... \$ 11.50

KUHN

Weld On

Skid Plate

FITS: Disc Mower Models: GMD500,

(GMD600 & GMD700; both with SN # 940001

& up); Replaces: VPN1034, 56801700,

568.017.00, 568-017-00, RW568017.

Use with 56801420 Stone Guard

ORDER # 56801700..... \$ 11.95



DISC BLADE HOLDERS

KUHN

FITS: Mowers GMD

44, 55, 66, 77.

(Not For Machines With

Reinforced Discs).

Replaces Kuhn # 562-007-00

ORDER # 1266603..... \$126.95



FITS: Two

Drum Mower

Model CM165, 166, 170.

ORDER # PZ116 \$ 20.95



Let your conversation be
without covetousness; and be
content with such things as ye
have: for He hath said, I will
never leave thee nor
forsake thee.

- Hebrews 13:5

VICON DISC - BLADE HOLDER

CM165, CM167, CM240 & CM247

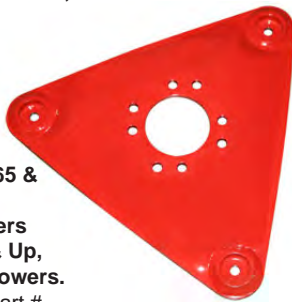

FITS: All CM165 & 167 Mowers, & CM240 Mowers Series 14022 & Up, & All CM247 Mowers. Replaces Old Part # 90016529
ORDER # B1019894..... \$174.95

DISC BLADE HOLDER CAP



FITS: All CM167, CM217 & CM247 Mowers, All CM216 Mowers
ORDER # 98664785..... \$ 49.95

DISC BLADE HOLDER HUB



FITS: All CM216 & CM217, CM167 & CM247 Mowers Replaces Old Part # 99421876
ORDER # 98621876..... \$134.95

ROLL PINS FOR ABOVE HUB

Roll Pin - Outer 13 x 60mm
ORDER # 30803719..... \$ 5.95

Roll Pin - Inner 8 x 55mm
ORDER # 30803855..... \$ 2.95

VICON DISC MOWER BELTS

FITS: CM165, CM167, CM216, CM217, CM240, CM247; Replaces: 43301603
NOTE: CM165 & 167 use 3; all others take 4); Priced Each

Blue Aramid, high heat resistance
ORDER # B92K \$ 24.95
 Black, Polyester cord
ORDER # B92 \$ 19.95



MISCELLANEOUS VICON PARTS

Hydraulic Cylinder Repair Kit

FITS: All Models
ORDER # 90083146..... \$144.95



Cutter Bar Bolts & Nuts Bolts have a Special Coating on the threads.

10mm X 20 - **ORDER # 90081616..... \$ 2.15**
 10mm x 25 - **ORDER # 90081617 \$ 3.25**
 10mm X 30 - **ORDER # 90081618..... \$ 3.25**

10mm Nut - **ORDER # 30583100..... \$.95**

STONE GUARDS & SKIDS

Stone Guard Less Skid

FITS: CM240 Outer End (Uses 2)
FITS: CM165 Outer End (Uses 4)
ORDER # 90015923..... \$ 65.95



Skid

11-1/4" overall length
FITS: All Mowers (Except CM240 Series 14018 - 14027)
ORDER # 90066591..... \$ 24.95



Skid

FITS: CM240 (Series 14018 - 14027)
ORDER # 90062054..... \$ 64.95

Plastic Insert

FITS: All Top Hats Replaces Old # 90070348
ORDER # 99770348..... \$ 8.95



BLADE HOLDER & GEAR PARTS

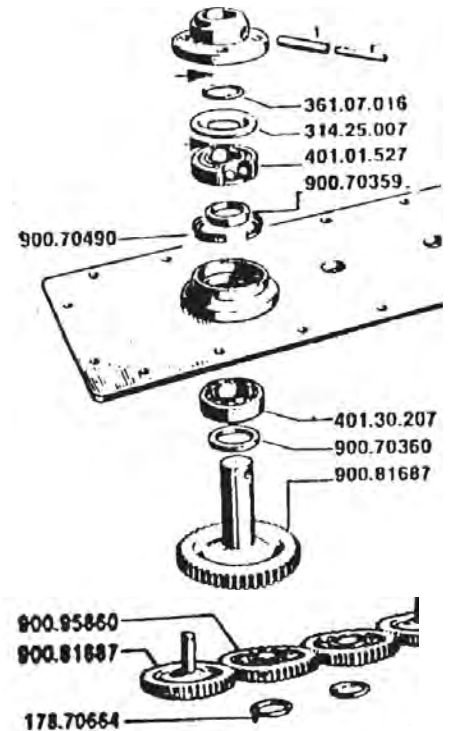

ORDER #	Description	Price
90095860	Gear - Idler (Uses Bearing # 40101008)	\$ 89.95
17870664	Spacer - Rubber	\$ 9.95
36107016	O Ring	\$.60
31425007	Bearing Shield	\$ 6.95
90070359	Bushing - Nylon	\$ 5.95
90070490	Snap Ring - Nylon	\$ 10.95
90070360	Spacer - Nylon	\$ 9.95
40130207	Bearing	\$ 34.95
40101527	Bearing	\$ 16.95
40101008	Bearing For Idler Gear	\$ 12.95

DISC MOWER BLADES

BUSH-HOG & NEW IDEA

NOTE: Length, Width & Hole Size Are Given in Inches and Millimeters

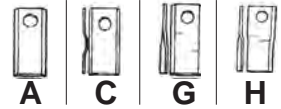

Application	OEM #	Length	Width	Hole Size		ORDER #		PRICE
BH & NI Old Series DM7, DM8, DM9, DM18, DM19	526215	4-23/32" (120mm)	1-57/64" (48mm)	47/64" (18.5mm)	RH	V58700Z	H	\$ 1.75
	526216				LH	V58699Z	H	\$ 1.75
BH & NI New Series DM70, DM80, DM90	527746BH	4-3/4" (121mm)	2" (50.80mm)	29/32" (22.6mm)	RH	NI527746Z	H	\$ 1.95
	527747BH				LH	NI527747Z	H	\$ 1.95
HM2007, HM2008, HM2009, HM2407, HM2408, HM2409		5" (127mm)	1.90" (48.26mm)	.843" (21.41 mm)	RH	50030318		\$ 2.65
					LH	50030319		\$ 2.65

DEUTZ FAHR & FELLA

Application	OEM #	Length	Width	Hole Size		ORDER #		PRICE
SM215 Mowers	121713RH	3-55/64" (98mm)	1-57/64" (48mm)	3/4" (19mm)	RH	F121713Z	H	\$ 1.95
	121712LH				LH	F121712Z	H	\$ 1.95
SM165, 206, 214, 240	122330RH	4-11/64" (106mm)	1-57/64" (48mm)	3/4" (19mm)	RH	F122330Z	H	\$ 2.05
	122329LH				LH	F122329Z	H	\$ 2.05
Old Style SM240, 120	478641 & 111725	4-23/32" (120mm)	1-57/64" (48mm)	47/64" (18.5mm)	RH	V58700Z	H	\$ 1.75
	478640 & 111724				LH	V58699Z	H	\$ 1.75
KM20, KM22, KM24, KM25, KM2.17, KM2.19, KM2.33		3.780" (96mm)	1.575" (40mm)	.750" (19mm)		ZKV96Z		\$ 1.95

GEHL

Application	OEM #	Length	Width	Hole Size		ORDER #		PRICE
DC1080, DM140, DM160, DC2350	60459RH	4-23-32" (120mm)	1-57/64" (48mm)	47/64" (18.5mm)	RH	V58700Z	H	\$ 1.75
	604658LH				LH	V58699Z	H	\$ 1.75
162 Mowers	613728	3-3/4" (95.5mm)	1-25/32" (45mm)	41/64" (16.25mm)	RH	K56151310Z	G	\$ 1.55
	613727				LH	K56151210Z	G	\$ 1.55

INTERNATIONAL

Application	OEM #	Length	Width	Hole Size		ORDER #		PRICE
Many Models	3164894R4	3-25/32" (96mm)	1-37/64" (40mm)	3/4" (19mm)		1266021 While supplies last	F	\$ 1.95
MD72, MD82, MD92, MDX71, MDX81, MDX91, TD102, & many other models.		4.33" (110mm)	2" (50.8mm)	.90" (22.8mm)	RH	9847683		\$ 1.70
					LH	9847684		\$ 1.70

KRONE

Application	OEM #	Length	Width	Hole Size		ORDER #		PRICE
Many Models	144826-1	3-35/64" (90mm)	2" (50mm)	3/4" (19mm)	RH	KR1448261Z	H	\$ 2.30
	144825-1				LH	KR1448251Z	H	\$ 2.30
Many Models	147-419	3-45/64" (94mm)	1-37/64" (40mm)	3/4" (19mm)	LH	KR41474191Z	H	\$ 1.60
	147-302				RH	KR41473021Z	H	\$ 1.60
Many Models	146-691-0	3-25/32" (96mm)	1-57/64" (48mm)	3/4" (19mm)	RH	KR1466911Z	H	\$ 1.95
	146-690-0				LH	KR1466901Z	H	\$ 1.95
Many Models	1398880	4.409" (112mm)	1.890" (50.44mm)	.748" (19mm)	LH	1266130	H	\$ 1.75
	1398890				RH	1266131	H	\$ 1.75

DISC MOWER BLADES

PZ - ZWEEGER & HESSTON & VERMEER

NOTE: Length, Width & Hole Size Are Given in Inches and Millimeters

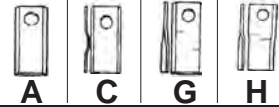

Application	OEM #	Length	Width	Hole Size		ORDER #		PRICE
CM135, 166, 167, 168, 170, 210, 211, 212, 220	CM120	4-9/64" (105mm)	1-27/32" (47mm)	53/64" (21mm)		ZCM120Z	C	\$ 1.55
CM215 Mowers	CM15	4-9/64" (105mm)	1-27/32" (47mm)	53/64" (21mm)		ZCM15Z	A	\$ 1.40
Hesston - 1030, 1040, 1050, 1060. Zweeger - 230, 265, 275, 320.	DM303	3.858" (98mm)	1.575" (40mm)	.640" (16.25mm)	RH	ZDM303Z		\$ 1.90
					LH	ZDM304Z		\$ 1.90

CASE - IH & VICON

Application	OEM #	Length	Width	Hole Size		ORDER #		PRICE
CM165, 167, 240, 247, CM1700, 2400, OM165, 241, KM165, 240, 241, 321, DMR2400, 3200, Case IH Models 3205, 3206	900/902 58700 Case # ZA526215 900/902 58699 Case # ZA526216	4-23/32" (120mm)	1-57/64" (48mm)	47/64" (18.5mm)	RH	V58700Z	H	\$ 1.75
					LH	V58699Z	H	\$ 1.75
CM216, 217, CM2200, OM216, 281, KM281,	900/902 65160 Case # 700711857 900/902 61559 Case # 700711858	4-7/32" (107mm)	1-57/64" (48mm)	47/64" (18.5mm)	RH	V61560Z	H	\$ 1.95
					LH	V61559Z	H	\$ 1.95
MD72, MD82, MD92, MDX71, MDX81, MDX91, TD102, & many other models		4.33" (110mm)	2" (50.8mm)	.90" (22.8mm)	RH	9847683		\$ 1.70
					LH	9847684		\$ 1.70

KUHN & JOHN DEERE & NEW HOLLAND & TARRUP

Application	OEM #	Length	Width	Hole Size		ORDER #		PRICE
GMD400/500, FC200, FC240/250, 280/300. NH Models 408, 411, 412, 415 JD - Models 1350, 1360, 1460, 1470, GMD600, GMD700; MoCo Models: 525 - 956	559-033-10 NH# 853820 559-032-10 NH# 853819	4-7/32" (107mm)	1-25/32" (45mm)	23/32" (18.2mm)	RH	K55903310Z	G	\$ 1.75
					LH	K55903210Z	G	\$ 1.75
GMD44, 55, 66, 77 NH - Many Models JD - Model 270	561-513-00 NH# 274097 561-512-00 NH# 274096	3-21/32" (93mm)	1-37/64" (40mm)	41/64" (16.25mm)	RH	K56151300Z	G	\$ 1.50
					LH	K56151200Z	G	\$ 1.50
GMD44, 55, 66, 77 NH Models 442, 452, 462 JD - Model 240 & 260	561-513-10 NH# 766727 561-512-10 NH# 766726	3-3/4" (95mm)	1-25/32" (45mm)	41/64" (16.25mm)	RH	K56151310Z	G	\$ 1.55
					LH	K56151210Z	G	\$ 1.55
GMD 44, 55, 66, 77 NH Models 463, 465 JD - Models 270, 1320 1326, 1327	564-513-00 NH# 748221 564-512-00 NH# 748220	4-27/32" (123mm)	1-25/32" (45mm)	23/32" (18.2mm)	RH	K56451300Z	G	\$ 1.80
					LH	K56451200Z	G	\$ 1.80
Tarrup Models 204, 205, 206	564-500-00	5-1/32" (128mm)	1-31/32" (50mm)	47/64" (18.5mm)		K56450000Z	D	\$ 2.95
Many Models NH - Many Models	561-500-00 NH# 274230	3-25/32" (96mm)	1-37/64" (40mm)	41/64" (16.25mm)		K56150000Z	A	\$ 1.50
Many Models	564-512-10	4-27/32" (123mm)	1-25/32" (45mm)	23/32" (18.2mm)		K56451210Z	A	\$ 1.75
Tarrup Models 204, 205 & 206	561-103-00	5-1/8" (130mm)	1-25/32" (45mm)	13/16" (20.5mm)		T56110300Z	D	\$ 3.90
Tarrup Many Models	58-372-000	4-5/16" (109mm)	1-37/64" (40mm)	13/16" (20.5mm)		T58372000Z	A	\$ 1.50

BUSHHOG - NEW - IDEA DEUTZ - FAHR & VICON

For Bush-Hog & New-Idea Mowers Using Blade
ORDER # V58700 & V58699
For Deutz-Fahr Mowers 324, 328, SM217, 221, 224. Using Blade
ORDER # V58700 & V58699
For All Vicon Mowers & Mower Conditioners.
Except New Mowers CM1700, CM2200, & CM2400.



10mm Thread Dia. Nylon Lock Nuts
KIT - Bolt & Nut
ORDER # 90081160K \$ 2.95

Vicon Mowers Only
12mm New Style
KIT - Bolt & Nut
ORDER # B1374593K \$ 3.95



Disc Mower Blade Bolt Kit
3/8" -24 UNF RH Thread Diameter.
ORDER # 527745K \$ 6.95

FELLA

FITS: SM215, 216
Sold As A Set
ORDER # F122181KZ \$ 6.95



FITS: Old
Style SM240, 120
KIT - Bolt & Nut
ORDER # 90081160K \$ 2.95



FORD/NEW HOLLAND

FITS: Models 615, 616, 617, 1409, 1410, 1411, 1412.
Nut Measurements: 1/2" - 13 RH Thread.
ORDER # 86515265 \$ 3.95



FITS: Models 615, 616, 617.
Bolt Measurements: 1" Thread Length,
1-1/2" o/a Length.
ORDER # 86515925 \$ 1.75

GEHL

For Models DC1080, DM140, DM160, DC2350,
Using Blade # V58700Z & V58699Z.
Use The Following Bolts & Nuts.
KIT - Bolt & Nut
ORDER # 90081160K \$ 2.95



Sitrex Mowers & For Gehl 162 Mowers
Using Blade # K56151310Z
& K56151210Z. 10mm & 15.9mm
Shoulder Dia.
KIT - Bolt & Nut
ORDER # 1266150K \$ 4.25

KRONE

12MM
FITS: Many Models.
KIT - Bolt & Nut
ORDER # 12660334K \$ 4.95



JOHN DEERE

10 MM
For Models 270
Using Blade # K56151300Z
& K56151200Z.
KIT - Bolt & Nut
ORDER # 12660489K \$ 3.50



For
Models 240 & 260
Using Blade # K56151310Z
& K56151210Z.
KIT - Bolt & Nut
ORDER # 1266150K \$ 4.25



12 MM
For Models 270, 1320, 1326,
1327, 1350, 1360, 1460, 1470
& More.
KIT - Bolt & Nut
ORDER # 12661489K \$ 3.25



FITS: MoCo Models: 525, 530, 535, 625, 630,
635, 730, 735, 830, 835, 910, 915, 916, 920,
925, 926, 930, 935, 936, 945, 946, 955, 956;
Replaces: E80242, E92221, FH313555
12mm Bolt & Nut
ORDER # SAE71254 \$ 5.60

KUHN

12 MM
FITS: Blades With
18.25mm Hole Heavy Duty.
FITS: Mowers GMD400,
500, 600, 700, FCD200, 250, 300, 350.
KIT - Bolt & Nut
ORDER # 12661489K \$ 3.25



10 MM Standard
FITS: Mowers GMD44,
55, 66, 77.
KIT - Bolt & Nut
ORDER # 12660489K \$ 3.50



TARRUP

10MM
Used With Blade #
T56110300Z & T58372000Z.
Bolt & Nut
ORDER # 56-294-000 \$ 3.55



MISC. NUTS

Metric
Nylon Lock Nut
10mm ORDER # 30577100 \$.50
12mm ORDER # M12LNT \$.50



BALE COUNTER

Baler Counter
4 Digit - With Arm -
Left Hand Pull. All Popular Balers
ORDER # U1000 \$ 29.95



BALER SHEAR BOLTS

Sold in packages of 10

Size - 3/8"-16 x 2 3/4"
ORDER # 35535 \$ 14.50



Size - 5/16"-18 x 2"
ORDER # 39716 \$ 4.50

Size - 5/16"-18 x 1 1/2"
ORDER # 46047 \$ 6.95

Size - 1/4"-20 X 1 1/2"
ORDER # 46520 \$ 6.95

Size - 7/16"-14 X 2"
ORDER # 226228 \$ 6.95



BALER SLIP CLUTCH DISC

FITS: Massey Ferguson Balers
Friction Slip Clutch Disc, Used In
Slip Clutch Assemblies On Round Balers:
450,560,1440, 1450,1550,1560;
ORDER # SC303132 \$ 8.95



BALE CHAMBER WEDGE

NEW HOLLAND
Retards Flow Of
Hay Thru Baler Thus
Allows For A More Dense Bale.
FITS: Any 14 X 16, 14 X 18, OR
16 X 18 Inch New Holland Baler.
Priced Each
ORDER # 32124 \$ 15.25



NH HAY BALER TINES

Front Tine,
14 Inches Curved
FITS: 280, 282, 290, 1280,
1282, 1290 Balers.
ORDER # 63339 \$ 16.95



Front Feeder Tine
FITS: 282, 283, 285, 286, 290,
420, 425, 430, 500, 1283, 1290 & 1425.
ORDER # 218790 \$ 24.95

BALER NEEDLES

NEW HOLLAND Baler Needle,
Used on many twine tie balers built in the last
30 Years. FITS: 268, 269, 270, 271,
273, 275, 276, 277, 278, 310, 315
and 320 Balers.
ORDER # 38762 \$ 89.95



PITMAN WOODS



UNIVERSAL
Length 37", Width one end 1-7/16", other 1-1/8"
ORDER # AWB395 \$ 24.95

FORD - FITS: No. 14-92 Mowers
37-11/16" Length.
ORDER # 149197..... \$ 24.95

FITS: No. 14-93 Mowers
46-7/16" Length.
ORDER # 149198..... \$ 36.95

JOHN DEERE - High Quality Hickory
FITS: No.'s 5,20,20A.
33-15/16" Long.
ORDER # PW9298..... \$ 24.95

FITS: No.'s 8,9,39N.
26-3/4" Long.
ORDER # PW9913..... \$ 24.95

INTERNATIONAL
FITS: Series 10,16,21, 24, 28;
35-11/16" Long.
ORDER # PW22184..... \$ 24.95

FITS: Series 12, 25, 27, 31;
31-3/4" Long.
ORDER # PW32119 \$ 24.95

MASSEY FERGUSON
FITS: No's 32,42,52; 34" Long.
ORDER # PW669434 \$ 31.95

PITMAN PARTS

FORD

(Front) Pitman Strap
ORDER # 143575..... \$ 37.95
(Rear) Pitman Strap
ORDER # 143576..... \$ 35.95

Pitman Lever
ORDER # 7501112 \$ 29.95
Spring
ORDER # 147857..... \$ 2.95

Pitman Box
Assy. W/Cups
ORDER # 147871..... \$109.95

Bearing Cups
ORDER # 8M1217..... \$ 5.95
Bearing Cones
ORDER # 8M1216..... \$ 15.95

Seal
ORDER # 141322..... \$ 8.95

INTERNATIONAL

Front Pitman Strap
ORDER # 143575..... \$ 37.95
Rear Pitman Strap
ORDER # 143576..... \$ 35.95

KOSCH GRASS BOARD



FITS: Sickle Mower
Mowers 501,
502, 515;
Adjustable Steel Rods
ORDER # SGB10..... \$ 43.95

SICKLE SECTIONS

Ford / New Holland - FITS: Sickle Mower
Models: 14-1, 14-2, 14-3, 14-4, 14-9, 14-10,
14-15, 14-15A, 14-16, 14-16A, 14-50, 14-51,
14-60, 14-61, 14-62, 14-63, 14-64, 14-65,
14-66, 14-68, 14-77, 14-140, 14-234, 14-257,
14-258, 14-259, 14-260, 14-280, 14-281,
14-282, 14-283; 501, 502, 515; Forage Har-
vester Models 605, 612, 680, 14-276, 14-305,
14-306; John Deere - FITS: Sickle Mower
Models 350, 450, 3700.
12 Gauge, Under Serrated, 3.250" Wide,
2" Center to Center Mounting Holes
ORDER # 126601..... \$ 1.50

International & New Holland -
FITS: All Mowers
Replaces INT # M22831
Size 3" x 3 3/16"
Heavy Underserrated Section.
ORDER # 126602..... \$ 1.60

Massey Ferguson -
FITS: All Mowers.
Replaces MF # 130356M1
Size 3" X 3 7/32"
Heavy Underserrated
ORDER # 126603..... \$ 1.80

UNIVERSAL END SECTION

Universal Non-Chrome
Underserrated End Section.
Eliminates Dead Space At End
Of Cutter Bar & Prevents Clogging.
Comes With Rivets.
ORDER # 1261977..... \$ 6.95

RIVET ASSORTMENT

Contains: 100 Rivets.
75 Of RIV111, 12 Of RIV103,
6 Of RIV113, 7 Of RIV114.
Enough To Service a 9 Ft. Sickle.
ORDER # 706227..... \$ 5.95

RIVETS

For Guard And Sections comes in one pound bag.
Oval Head Rivets
5-1/2" X 1/2" | ORDER # RIV105 \$ 6.95
5-1/2" X 9/16" | ORDER # RIV101 ... \$ 7.95
5-1/2" X 3/4" | ORDER # RIV107 \$ 6.95
5-1/2" X 1-1/16" | ORDER # RIV106 \$ 9.95
5-1/2" X 1-1/4" | ORDER # RIV113 .. \$ 5.95
Countersunk Rivets
6 X 1-1/2" | ORDER # RIV104 \$ 6.95

KNIFE CLIPS



Hi-Arch
FITS: Ford 14-1, 3, 4, 9, 10,
15, 16, 50, 51, 61, 62, 63, 64, 65,
66 Mowers.
New Holland - FITS: All Mowers, For Models
Ferguson AEO-A20, AEO-B20, PEO-21. 1942 - Up.
ORDER # 141008..... \$ 36.95

Lo-Arch
Universal Non-Adjustable Hold
Down Clip. Steel, Riveted or Bolted
sickles. Can be used on Twin Point Bolt-on Sections.
ORDER # MA812 \$ 5.95

RIVETED SICKLE ASSY



FITS: Ford Mowers Series 505
& 505 Rear and Side Mounted.
Mowers # 501 Series, 14-94,
95, 96, 97, 175, 176, 237, 258, 259, 260.
Using Underserrated Sections. **This Item**
Has ADDITIONAL Handling Charges.
7 Ft. | ORDER # 148119 \$189.95

WEAR PLATES

UNIVERSAL
FITS: Below Mowers
AC# 1116532, 1176537
Deere # E47954, Z5936H
Ford #141021 & 242046
Gehl # H7543
IHC #MC468, 179759C1 & OMC #110-10645
Kosch #K162 & Love #L220
MF# 206196M1 & MF# 231303M1
NH #26616,271967 & White # 501015E
Priced Each
ORDER # 1265290 \$ 3.95

MOWER GUARDS

UNIVERSAL
Center Guard
FITS: Allis Chalmers,
Anderson, Case, John Deere,
Hesston, IHC, Gehl, Kosch, Massey
Ferguson (LA67 & L215), Minnesota,
New Holland, New Idea, Oliver & Triumph.
INTERNATIONAL & John Deere
Single Guard
FITS: 7/16" Bar
ORDER # DM700..... \$ 8.50

Center Guard
FITS: Allis Chalmers,
Case, Detroit (N-12 & 15294),
Ferguson, Ford, Massey Ferguson,
Oliver And Worthington. For 1/2" bars.
ORDER # FD800..... \$ 9.50

RIVET PUNCH

Rivet Punch; Designed For
Heading Section Rivets. Alloyed
Steel, 5" Long, 5/8" Dia. 3/8" Point.
ORDER # CT4030RS..... \$ 13.95

HYPRO ROLLER PUMPS

4 Roller

Model 4101C-

Delivers 150 PSI,
7 GPM at 2600 RPM.
Used With Gasoline Engines.
Ports 3/4" with a 5/8" Solid Shaft.

ORDER # 4101C \$ 89.95



6 Roller Model 6500C -

Cast Iron
Ports 3/4", Shaft Size 5/8".

Operates at speeds up to
1000 RPM. Output 7.4 GPM at
540 RPM; 15 GPM at 1000 RPM.

ORDER # 6500C \$ 157.95



8 Roller Model 7560C

Cast Iron.
Ports 3/4", Shaft Size 15/16".

Operates at speeds up to 1000
RPM. Output 11.4 GPM at 540 RPM;
22 GPM at 1000 RPM.

ORDER # 7560C \$ 205.95



PUMP REPAIR KITS

For Hypro Roller Pumps

Kit Contains Nylon Rollers, "O" Ring, Viton Seals.

For 6 Roller

ORDER # 34300175..... \$ 29.95



For 7 Roller

ORDER # 34300169..... \$ 38.95

For 8 Roller

ORDER # 34300167..... \$ 44.95

BATTERY OPERATED PUMP

BATTERY OPERATED 12 VOLT PUMPS
SHURFLO Brand.

FEATURES:

Self Priming Up to 8 Feet
Chemical Resistant Materials
Designed For Heavy Duty Spraying
And Fluid Transfer Applications.
Can Run Dry Without Damage



To Fit Many Different Model Sprayers.

1.0 GPM - 35 PSI 3/8" Female Ports

ORDER # 527-5086..... \$ 58.95

1.8 GPM - 60 PSI 3/8" Female Ports

ORDER # 8007-593-836 \$ 97.95

2.1 GPM - 100 PSI 3/8" Female Ports

ORDER # 8007-594-838 \$ 98.95

2.2 GPM - 100 PSI 3/8" Female Ports

ORDER # 8001-598-8138 \$ 99.95

3.0 GPM - 45 PSI 1/2" Male Ports

ORDER # 2087-593-135 \$129.95

PUMP COUPLERS

NOTE: Standard Couplers Use Allen Head Set
Screws For Mounting Coupler to Pump & PTO
Shaft. Quick Couplers Are Quick, Simple And
Easy On/Off. Just Pull
Collar Back And Slide
Off P T O Shaft.



FITS: 5/8" Shaft

Std. Coupling 1-3/8" x 6 Spline.
ORDER # 13200022..... \$ 20.95

Quick Coupling 1-3/8" x 6 Spline.
ORDER # 13210006..... \$ 38.95

Quick Coupling 1-3/8" x 21 Spline
ORDER # 13210008..... \$ 48.95

FITS: 15/16" Shaft

STD. Coupling 1-3/8" x 6 Spline
ORDER # 13200033..... \$ 20.95

Quick Coupling 1-3/8" x 6 Spline
ORDER # 13210007..... \$ 41.95

Quick Coupling 1-3/8" x 21 Spline
ORDER # 13210009 \$ 45.95

PUMP TORQUE KIT

Keeps Pump From Rotating.

FITS: Hypro Roller
Pumps 6 & 8 roller,
May Fit Others With
A 2 1/8" Hole Center.

ORDER # TK24..... \$ 12.95

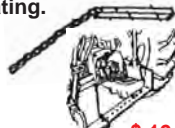

PRESSURE GAUGE

Standard
Metal Gauge
2" Case -1/4" NPT.
0-200 PSI
ORDER # SG2002 \$ 7.95



SHUT OFF VALVES

Bronze Ball Valves Has A
Working Pressure Up to 200 PSI.
NPT Female Threaded Ends.



Size 1/2" ORDER # 940103..... \$ 12.95

Size 3/4" ORDER # 940104..... \$ 13.95

REGULATING VALVES

Nylon Construction
Male Port 1/2", Female 3/4".
ORDER # 2064-05-58 \$ 18.95



Brass Construction
1/2" Ports
ORDER # 2042-1 \$ 24.95

P T O SPRAYER KITS

This Kit Has A Number Of Possible Uses:
Livestock, Or Orchard Spraying. Crop Or
Fence - Row Spraying, Weed Or Insect
Control, And Cleaning Machinery Or
Outbuildings. Kit Sold Unassembled.
Simple, Easy to Assemble, With Instructions.



Complete As Pictured.

Kit Contains: Hypro 6 Roller Pump,
With Quick Connect Pump Coupler,
Torque Kit, 13" Pistol Grip Spray Gun
With 25 Ft. Hose, All Other Necessary
Hoses, Clamps, Fittings, Regulating Valve,
Strainer, Gauge.

ORDER # CSK6..... \$369.95

SUCTION STRAINERS

Nylon
Suction Strainer
FITS: 3/4 Hose
50 Mesh.



ORDER # 33500032..... \$ 14.95

FITS: 3/4" Male
Pipe Thread



ORDER # 33500069..... \$ 14.95

HYPRO STRAINERS

Hypro 3350
Series - Ports
Have Stainless
Steel Ferrule
Reinforcements.
Durable
Polypropylene Material.
50 Mesh.



3/4" Ports ORDER # 33500034A \$ 14.95

1" Ports ORDER # 33500058A \$ 19.95

*What things so ever you
desire, When you pray,
believe that you
Receive them and
you shall Have them.*

— Mark 11:24

15 - 25 & 55 GALLON SPOT SPRAYERS

12 Volt Battery Operated

CAN SHIP
FedEx



Simple, easy to operate. Mounts on any ATV or Garden Tractor with 12 volt electric start. Ideal for lawn, garden, fruit trees, any where spot spraying is needed. Comes completely assembled with parts and instruction manual. Features a 12 volt self priming pump. Delivers 1.4 GPM at 50 PSI. The hand gun is light weight, chemical restraint with lock on trigger, adjustable nozzle with strainer for fan or stream spraying. Sprays up to 20 ft. Tank features include molded in recessed tank ends for easy handling, large 5" tank opening with vented cap for easy filling, flat bottom with drain plug, bottom tank has molded in treaded inserts to allow a variety of mountings.
30" L x 15" W x 14" H. | Wt. 20 Lb.

- ORDER # M-SS15 | 30" L x 15" W x 14" H | Wt. 20 \$ 189.95
- ORDER # M-SS25 | 34" L x 18" W x 17" H | Wt. 30 \$ 199.95
- ORDER # M-SS55 See Equipment Section (Page 7) For Features..... \$ 399.95

Trailer Models

Ideal For towing behind a Lawnmower, ATV or Garden Tractor.
Same Sprayer as the above sprayers. Can Not Be Shipped UPS.
25 Gallon Sprayer ORDER # SS25TM \$ 389.95

OPTIONAL: Boom Assembly 8 ft Coverage with 5 Teejet Nozzles, for above Trailer Model Sprayer. ORDER # SSBA \$ 140.00

SPRAY GUNS & REPAIR KITS

GunJet
Model 43H



Brass 22" Hand Gun for Operating Pressure up to 800 PSI. Trigger Handle Control with 1/2 x NPT Inlet Connection. Quality Designed and Built for Heavy Duty Service. Stem Extends Through Extension to Valve Seat Located directly Behind Orifice Disc For Drip-Free Shutoff And Instant Operating.Response. Convenient Trigger-Lock for Continuous Spraying.
ORDER # AA43H..... \$ 121.95

Repair Kit For Above Spray Gun # AA43H
ORDER # PKAB43KIT..... \$ 29.95

HAMILTON SPRAY GUN



Rotating Handle Adjustment from stream spraying to mist. Rated at 400 PSI. Length 23", 3/4" Garden Hose Connection.
Wt. 4oz. ORDER # 10052 \$ 39.95

Repair Kit
For Gunjet Gun # 143AL & Hamilton Gun # 1005-2
ORDER # 100500500..... \$ 9.95

HYPRO SPRAY GUNS

Heavy Duty Trigger Spray Gun
This Gun Features A No Drip Shut Off At The Nozzle With Trigger Locks For Both Safety Lock Off And Spray Angle Adjustments. The Spray Angle Adjusts From Straight Stream To Wide Cone. Made of Stainless Steel and Brass.



TWO MODELS AVAILABLE

- Maximum Pressure Rating: 600PSI
- Maximum Capacity: 4.5GPM
- Port: Size 1/2" Hose Barb

Barrell Length of 7-1/4"
ORDER # 3381-0043 \$ 92.95

Barrell Length of 18"
ORDER # 3381-0043L \$104.95

HAMILTON SPRAY GUNS

Sprays from 30 to 40 ft. 800 PSI.
Barrel Length 13"
3/4" Port
ORDER # 170002013 \$ 43.95
Barrel Length 22"
3/4" Port
ORDER # 170002022 \$ 46.95



HORIZONTAL SPRAYER TANKS

All Tanks are Shipped Freight Collect From Factory



Gallon	Diameter X Length	ORDER #	PRICE
55	23" x 37"	47337	\$ 189.95
150	32" x 50"	47082	\$ 299.95
325	38" x 68"	41345	\$ 529.95

FITTINGS FOR POLYETHYLENE TANKS

COMPLETE FITTING
Consists of Fitting Body, O-Ring & Nut

1/2"		ORDER # 67161	\$ 16.50
3/4"		ORDER # 67160	\$ 16.50
1"		ORDER # 67162	\$ 16.50
1-1/4"		ORDER # 67155	\$ 18.95
2"		ORDER # 67153	\$ 18.95
1-1/2"		ORDER # 67154	\$ 18.95

SPRAY GUNS BY TEEJET



The **Trigger Jet** is a Lightweight Spray Gun Designed for Use With Backpack, Canister or Other Low Pressure Spray Systems. It is Constructed of Molded Polypropylene for Excellent Chemical Resistance And Durability. Max. Pressure Rating is 150PSI. Works With 3/8" ID. Hose.

32" Overall Length
ORDER # 22670-PP \$ 36.95



23" Overall Length
ORDER # 50800 \$ 17.95

TRIGGER JET GUN PARTS

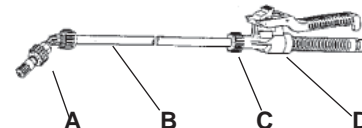

- A - Adjustable Cone Jet Tip w/Cap
ORDER # 5500-PPB-X8-V1 \$ 9.95
- B - Extension Tube with "O" Rings
15" ORDER # CP22663-15-FRP... \$ 10.95
24" ORDER # CP22663-24-FRP .. \$ 14.95
- C - Cap - ORDER # CP22668-PP \$ 1.95
- D - Trigger Assembly Complete
ORDER # 22650-PP-406 \$ 21.95

SPRAY GUN ORFICE DISC

Hardened Stainless Steel Type D Orifice Disc

Five Interchangeable orifice disc. Discs are corrosion and erosion resistant. Size # 3 To # 8. Fits Most GunJet Guns.



ORDER By # D3 Through # D8.....\$ 1.50 ea.

GALVANIZED MANIFOLD

1/2" NPT Outlets With 1/4" Threaded Port For Pressure Gauge.



ORDER # 64393T.....\$ 12.95

PVC SHUT OFF VALVE

PVC Shut Off Valve Used on Boom Assemblies.



ORDER # 940-284 \$ 7.95

SPRAY HOSE

Red Ultra Flex Spray Hose, Average Farm Use Fully Oil And Chemical Resistant. 300 PSI Working Pressure. Priced Per Foot.



3/8" ORDER # 3014412.....\$.75
1/2" ORDER # 3014416.....\$.95
3/4" ORDER # 3014424.....\$ 1.50

CLEAR BRAIDED HOSE

Braided Clear And Flexible For Low Pressure Spraying. Maximum Visibility. Used Mostly With Boom Applications. Priced Per Foot



3/8" ORDER # K3150.....\$ 1.00

CLEAR TUBING

Clear And Flexible For Low Pressure Spraying. Maximum Visibility. 100PSI Working Pressure. Used Mostly With Boom Applications. Priced Per Foot



1/2" ORDER # 1971.....\$.50

LIL NIPPER

- Cuts: Polyethylene Polybutylene PVC - ABC - Rubber Hose. - All Sizes Up To 1 1/4" I.D
- Fast - Clean - Safe - Small - Light
- Strong Tough Nylon Handles
- Replaceable Stainless Steel Blades

ORDER # 456241.....\$ 21.95



SPRAYER BOOM PARTS

FLAT SPRAY NOZZLE TIPS

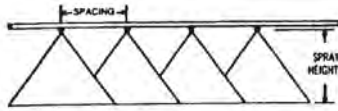

For Broadcast Boom Spraying Most Common On 20" Spacing. Delivers A Fan Shaped Spray Pattern, Finely Tapered At Each End. Polymer Nozzle Tip.



ORDER # TP11002VP\$ 1.00

Brass Nozzle Tips



ORDER # TP8002.....\$ 4.30

Many Other Sizes Available Call For Application

NYLON BOOM FITTINGS

All 1/2" NPT

Nylon "T" Nozzle With Locknut.



ORDER # NTT12.....\$ 2.25

Nylon "L" Nozzle With Locknut.



ORDER # NTL12.....\$ 2.25

Nylon "X" Nozzle With Locknut.



ORDER # T12C.....\$ 2.25

Brass Strainer Mesh



ORDER # 451410.....\$ 1.00

Nylon Nozzle Cap



ORDER # 8027.....\$.50

Nylon Lock Nut



ORDER # B12.....\$.50

Complete Assembly With Above Parts Including Nozzle Tip # TP11002VP

Nylon "T" ORDER # NTC\$ 4.95
Nylon "L" ORDER # NLC\$ 4.95
Nylon "X" ORDER # NXC\$ 4.95

Blank Disc Used To Shut Off A Nozzle. ORDER # CP3942\$.35

NOZZLE MOUNTING PLATE

For Easy Mounting Of Nozzle On Boom. Easy Adjustment Just Slide On Pipe.



FITS: 1" Round Tubing ORDER # BC100R.....\$ 2.00

FITS: 1" Sq. Tubing ORDER # BC100\$ 2.00



BROADCAST NOZZLE

For Broadcast Spraying Of Chemicals, In Pastures, Orchards, Anywhere A Boom Is Not Useable.



Brass Nozzle 3/4 - 2TOC10 Is

The Most Common Nozzle Used. GPM Capacity 2.8-4, Spray Width 40', Gallons Per Acre (Depends On Tractor Speed) 2.4-12.2 Other Sizes Available.

ORDER # 58803/42TOC10.....\$ 181.95

B-OC10 Tip GPM 2-4.9, Spray Width 38-41'. ORDER # OC10\$ 36.95

B-OC20 Tip GPM 4.3-10.5, Spray Width 41-54'. ORDER # OC20\$ 36.95

B-OC40 Tip GPM 8.5-20.8, Spray Width 48-66'. ORDER # OC40\$ 36.95

C-Veejet Bottom Nozzle VVL-11004 With 50 Mesh Strainer.

ORDER # H1/4V VL11004\$ 9.95

A-Veejet Top Nozzle H14U-0508HE (Two Required). Pair.

ORDER # H1/4U0508HE\$ 6.95

BOOMLESS NOZZLES



Ideal Nozzles For Wide Coverage, Up To 52 Ft., Provides Even Spray (180 Degrees) Distribution. See Chart Below. GPM = Gallons Per Minute. 1/2" Female Port

Nozzle # BN5

BN10

PSI	GPM	Swath 180'	Gallons Per Acre					
			3 MPH	4 MPH	5 MPH	8 MPH	10 MPH	
30	1.7	44'	5.4	4.8	3.8	2.4	1.9	
40	2.0	46'	7.2	5.4	4.3	2.7	2.2	
50	2.2	48'	7.8	5.7	4.5	2.9	2.3	
60	2.4	50'	7.9	5.9	4.8	3.0	2.4	
80	3.7	50'	12.2	9.2	7.3	4.6	3.7	
40	4.2	50'	13.9	10.4	8.3	5.2	4.2	
50	4.6	52'	14.6	10.9	8.8	5.5	4.4	
60	5.0	52'	15.8	11.9	9.5	5.9	4.8	

ORDER # BN5\$ 27.95
ORDER # BN10\$ 27.95
ORDER # BN2 For ATV's.....\$ 27.95

Also available for ATV's. See the Sprayer Section.

NOZZLE MOUNTING BRACKET

For Mounting Boomless Nozzles. 1/4" Thick Steel X 1 1/2" Wide X 12" Long With Set Collar. (Use with Steel Hose Adapter # 973870)



ORDER # NMB | Fits NOZ Nozzles.....\$ 12.95

Steel Hose Adapter ORDER # 973870.....\$ 4.95

CULTIVATOR SWEEPS

Hole Spacing 2" - Bolt Hole Size 7/16".
Center Hole 5/8" Carriage Bolt.



Size	ORDER #	Price
4"	31604	\$ 9.50
6"	31606	\$ 10.50
8"	31608	\$ 10.95
10"	31610	\$ 12.50
12"	31612	\$ 13.95
14"	31614	\$ 14.95
16"	1416	\$ 22.95
18"	1418	\$ 26.95
20"	1420	\$ 35.95

CULTIVATOR BOLTS

Plow Head Bolts With Nuts & Lockwashers

7/16" X 1 1/2"	\$.65
7/16" X 2"	\$.70
7/16" X 2 1/2"	\$.75
7/16" X 3"	\$.80



Carriage Head Bolts With Nuts & Lockwashers

5/8" X 3"	\$.90
5/8" X 3 1/2"	\$.95
5/8" X 4"	\$ 1.00
3/4" X 3"	\$ 1.40
3/4" X 4"	\$ 2.15



"What things so ever you desire When you pray, believe that you receive them and you shall have them".
— Mark 11:24

LISTER FURROWER

Used For Bedding, Opening Small Furrows For Drainage, For Potato Digging. Center Hole is 5/8". Uses a Carriage Head Bolt.



12"	ORDER # 48818.....	\$ 19.95
15"	ORDER # 36793.....	\$ 23.95

TEXAS BUSTER

Heavy Duty 1/4" Thick. Punched With One Hole For 3/4" Carriage Bolt.



12"	ORDER # 12SQ.....	\$ 34.95
15"	ORDER # 15SQ.....	\$ 37.95

CULTIVATOR PARTS

For Various Cultivators

Tine
3/8" Thick x 1-3/4" Wide
30" Overall Length.
Has Slotted Hole To Accomodate Different Size Hole Centers In Sweeps.
ORDER # 10406..... \$ 15.95



Spring Tooth Point Universal Slotted
Hole Center 1-3/4" To 2-1/4"
2" Wide X 10 1/4 Length.
ORDER # 15511 \$ 4.95



Tine Holders
FITS: 2" SQ Toolbars
ORDER # TH200..... \$ 9.95

FITS: 2-1/2" SQ Toolbars
ORDER # TH250..... \$ 9.95

RIGID SHANK CULTIVATOR PARTS

Left Half Shank Clamp
ORDER # 14539..... \$ 14.95



Right Half Shank Clamp
ORDER # 14538..... \$ 14.95



Shank Foot Washer
ORDER # 686187M1..... \$ 1.95



CULTIVATOR PARTS

Shank Foot Washer
ORDER # 686187M1 \$ 1.95



Cultivator Shank
20" Tall
1-1/4" Dia. Shank
5-1/2" Spring
1-5/8" Spring Diameter
Heavy Duty Shank.
Priced Each.
Requires Additional Handling Charge.
FITS: Many Internationals
ORDER # 38854 \$ 89.95



DISC HILLER PARTS

For Sealed Bearing Disc Hillers
DH30525 & DH31752

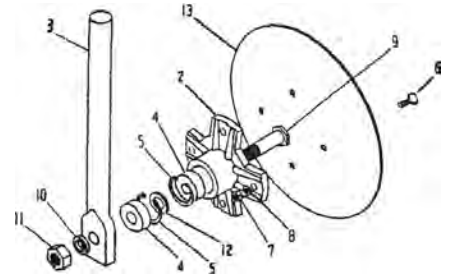

Ref.	Description	Order #	PRICE
2.	Hub Only - No Brgs	11679	\$ 10.95
2.	Hub With Bearings	11679C	\$ 42.95
3.	Shank 22" 1-1/4" Rd	30336	\$ 15.95
4.	Bearing (2 Req'd)	17849	\$ 11.95
5.	Snap Ring	27936	\$ 1.25
6,7,8	CHBolt 5/16" x 1-1/2	BK4	\$ 2.50
9.	Special Bolt	29842	\$ 4.95
13.	Blade 14"	25900	\$ 19.95
13.	Blade 16"	25901	\$ 23.95

CLAMPS & HOLDERS

FITS: 1-1/4" Round Shanks. Tractor Model - International, Farmall Cub, A, Super A, 100, 140, C, Super C, 274,265. Also Fits Kubotas.
NOTE: Does Not Include Wedge Bolt & Nut.



Cultivator Clamp Closed
ORDER # 511985R2..... \$ 19.95

Wedge Bolt & Nut
FITS: Above Clamps.
ORDER # 512384R1..... \$ 6.95



5/8" U-Bolt With Nuts
FITS: Original Clamp FC1002
ORDER # FCUB58..... \$ 9.95

Lay Off Clamp & Wedge Assy
FITS: Super A
ORDER # 29600BA \$ 39.95



Wedge Only
FITS: Lay Off Clamp
ORDER # 29600W \$ 11.95



DISC BLADES

DISC AXLES



All Blades Are Notched

Notched - Precision
Double Bevel Edge



Disc Blade Thickness Chart

Gauge	MM	Fraction	Decimal
7	4.5	3/16" +	.187
9	3.5	9/64" -	.138
11	3	1/8"	.125
1/4"	6	1/4"	.250

NOTCHED - Disc Blades

Axle Size	Blade O.D.	Gauge	ORDER #	Price
7/8" SQ X 1" RD	16"	11 Ga.	602381	\$ 17.95
1" X 1 1/8" SQ	16"	11 Ga.	36833	\$ 16.95
1" X 1 1/8" SQ	16"	7 Ga.	12116922	\$ 26.95
7/8" SQ X 1" RD	18"	11 Ga.	12118900	\$ 18.95
1" SQ	18"	11 Ga.	38119	\$ 17.95
1" X 1 1/8" SQ	18"	11 Ga.	30242	\$ 18.95
1 1/8" X 1 1/4"	18"	7 Ga.	12118923	\$ 21.95
1 1/2" RD	20"	9 Ga.	12120156	\$ 23.95
1" SQ	20"	9 Ga.	38121	\$ 22.95
1" X 1 1/8" SQ	20"	9 Ga.	36836	\$ 24.95
1 1/8" X 1 1/4" SQ	20"	9 Ga.	12120913	\$ 28.95
1 1/2" SQ	22"	1/4" Ga.	78684	\$ 39.95
1 1/8" X 1 1/4" SQ	22"	7 Ga.	12122923	\$ 31.95

*These Are Just a Few of the Blades We Carry
Give Us A Call If Your Blade Is Not Listed*

BLADES FOR ECONOMY DISC HILLERS

FITS: 3/4" Round Axle
Plain Blade - & Notched



12" Blade Notched	ORDER # DB12N	\$ 11.95
12" Blade Plain	ORDER # DB12P	\$ 11.95
14" Blade Plain	ORDER # DB14P	\$ 12.95
14" Blade Notched	ORDER # DB14N	\$ 12.95

JOHN DEERE - M&W - CANE CULTIVATORS

DISC HARROW BEARINGS

Disc Harrow Bearing Kit With Seals.

Double - Back to Back Tapered Roller Bearing
With Extended Inner Race, Plus Two Replacement
Lip Type Seals.

1.531" Square Bore

FITS: John Deere Disc Harrows 1630, 1365, 1640, TW & TWA.

Priced Each

ORDER # SAB14028.....\$139.95



Length Measured Under Head
7/8" Square With Regular Square Head.

Length	ORDER #	Price
26 3/8"	T15	\$ 29.95
33 1/2"	T16	\$ 29.95
41-1/2"	T13173	\$ 39.95

See Disc Harrow Parts For 1" & 1-1/8"
Square Disc Axles.

" W " SERIES DISC BEARINGS

- Import
- Triple Lip Seals
- Precision Ground



• IMPORT



Bore	Shape	Outside Dia.	ORDER #	Price
7/8"	SQ.	80MM (3 5/32")	W208PPB13-IMP	\$ 22.95
7/8"	SQ.	3 7/16" Spher.	W208PPB11-IMP	\$ 22.95
1"	SQ	80MM (3 5/32")	W208PPB6-IMP	\$ 17.95
1 1/8"	SQ.	80MM (3 5/32")	W208PPB5-IMP	\$ 17.95
1 1/8"	SQ.	80MM (3 5/32")	W208PPB8-IMP	\$ 22.95
1 1/8"	SQ.	3 7/16" Spher.	W208PPB12-IMP	\$ 19.95

STEEL FLANGE HOUSING

4 Bolt Round — Priced Per PAIR



O.D.	ORDER #	Price
80MM	F480	\$ 10.50
85MM	F485	\$ 12.95
90MM	F490	\$ 16.95
100MM	F4100	\$ 19.95

GREASABLE		
O.D.	ORDER #	Price
80MM	F4Z80	\$ 13.95
85MM	F4Z85	\$ 13.95
90MM	F4Z90	\$ 17.95
100MM	F4Z100	\$ 16.95

INTERNATIONAL

DISC BEARINGS

High Quality Import Bearing,



















Triple lip seals. 1.7700" I.D., round bore,
re-lubricatable, 5" x 5" O.D., Self-aligning

bearing built to resist shock, comes mounted in riveted flanges with four
bolt holes, includes grease fitting. FITS: Disc Harrow Models 37
(1962 & up), 46, 48, 60, 120 (1967 & up), 122, 130, 132, 150, 330, 350,
370, 470, 475, 480, 490, 610, 760. Replaces ST427, ST490, ST627.

ORDER # ST491A\$ 24.95



**** There Will Additional Freight Added to ALL Cast & Steel Products Listed on Pages 69 - 71**

FITS: MOST DISC WITH 1" SQUARE AXLES		FITS: MOST DISC WITH 1 1/8" SQUARE AXLES	
BEARING ASSEMBLY COMPLETE <small>WITH BOLTS</small> Assembly ORDER # CFG221C \$ 29.95 		BEARING ASSEMBLY COMPLETE <small>WITH BOLTS</small> With 7-1/2" Ribbed Spool **ORDER # BAC750 \$ 69.95 	
RIBBED SPOOL  Can Be Used For A Plain Spool Length - 7-1/2" ORDER # CFG1 \$ 11.95	BEARING HALF <small>WITH GREASE FITTING</small>  Hole Centers 3" ORDER # CFG2 \$10.95	RIBBED SPOOL Length - 7-1/2" 1-1/8" Spacing Between Ribs. ORDER # 1182011 \$ 29.95 	BEARING HALF <small>WITH GREASE FITTING</small>  Hole Centers 4" Overall Width 5-1/2" ORDER # 1182010 \$ 19.95
BUMPER WASHER  Diameter — 6-1/2" ORDER # CFG4 \$ 10.95	END WASHER  Diameter — 3-1/2" ORDER # CFG3 \$ 4.95	BUMPER WASHER  Diameter - 4-3/4" ORDER # 1182013 \$19.95	END WASHER  Diameter 4-1/4" ORDER # 1182021 \$13.95
SEALED BEARING ASSEMBLY COMPLETE <small>WITH FLANGES AND BOLTS</small> Assembly ORDER # SBACK \$ 28.95 		BEARING SPACERS <small>FOR SEALED BEARING DISC HARROWS</small> 	
BEARING SPACERS <small>FOR SEALED BEARING DISC HARROWS</small>  Spacer - 2 3/8" ORDER # CFG7 \$ 7.95 Spacer - 3 5/8" ORDER # CFG8 \$ 8.95	SEALED BEARING  Bearing ORDER # W208PPB6IMP \$17.95	BEARING SPACERS <small>FOR SEALED BEARING DISC HARROWS</small>  Spacer - 1-3/4" ORDER # 1182022 \$ 13.95 Spacer - 3" ORDER # 1182018 \$ 16.95 Spacer - 4-1/2" ORDER # 1182023 \$ 19.95	
AXLE LOCKING PLATE  Keeps Nut From Backing Off ORDER # AEK100 - FITS: 1" Axle \$ 3.25		AXLE LOCKING PLATE  Keeps Nut From Backing Off ORDER # AEK125 \$ 2.00	
1" SQUARE AXLES WITH NUT  18-1/2" ORDER # DA1018 \$21.95 26" ORDER # DA1026 \$24.95 31" ORDER # DA1031 \$31.95 33" ORDER # DA1033 \$32.95 41" ORDER # DA1041 \$38.95		AXLES WITH NUT <small>Steel Prices are Subject to Change Please Call For Current Prices</small>  12-1/2" ORDER # T125 \$ 23.95 18-5/8" ORDER # T130 \$ 39.95 22" ORDER # T131 \$ 39.95 26-1/4" ORDER # T132 \$ 39.95 31" ORDER # T13 \$ 49.95 34-1/8" ORDER # T133 \$ 49.95 40-1/4" ORDER # T14 \$ 59.95 41-1/2" ORDER # T141 \$ 59.95 49-1/4" ORDER # T142 \$ 62.95 56-5/8" ORDER # T143 \$ 69.95 58-1/2" ORDER # T144 \$ 69.95	



COVINGTON TP 46 PLANTER PARTS

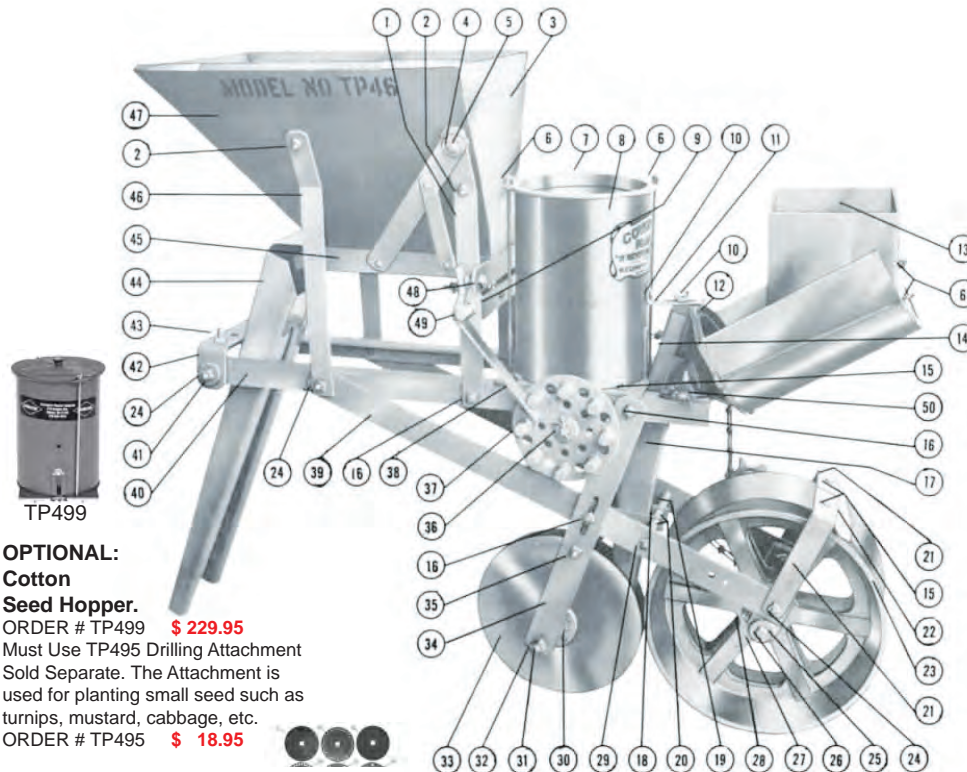

OPTIONAL:
Cotton Seed Hopper.
 ORDER # TP499 \$ 229.95
 Must Use TP495 Drilling Attachment Sold Separate. The Attachment is used for planting small seed such as turnips, mustard, cabbage, etc.
 ORDER # TP495 \$ 18.95

Ref #	ORDER #	Description	Price
1	TP88	Rear Fertilizer Box Brace	\$ 16.95
5	TP34	Vibrating Pan Bushing	\$ 6.95
6	TP65	Can Rod For Cotton & Grain Attachement	\$ 3.95
8	TP36	Cotton Can (Round)	\$ 26.95
9	TP80	Vibrating Pan Yoke	\$ 6.95
11	TP93	Grain Attachment Bracket Holder	\$ 3.50
12	C900	Grain Attachment Bottom	\$ 59.95
13	TP94	Grain Attachment Seed Can	\$ 48.95
17	TP66	Seed Spout (Main)	\$ 19.95
22	TP55	Press Wheel Scrape (Each)	\$ 7.95
25	TP14	Presser Wheel Shaft Bearing	\$ 15.95
30	TP513	Disc Bearing	\$ 20.95
32	TP49B	Square Steel Axle For Disc Bearing 9/16" X 10"	\$ 16.95
33	TP19	Opening Disc 12"	\$ 17.95
36	TP38	Stirring Shaft Only (7/16" X 10-3/4" Square)	\$ 15.95
37	TP2	Drive Vibrator	\$ 40.95
38	TP82A	Vibrating Arm Only	\$ 9.95
39	TP59	Press Wheel Pull Arm	\$ 28.95
41	TP33	Pull Yoke Bearing	\$ 5.95
42	TP68	Front Pull Yoke	\$ 13.95
44	TP77	Fertilizer Spout	\$ 39.95
45	TP79A	Vibrating Pan Only	\$ 47.95
46	TP87	Front Fertilizer Box Brace	\$ 14.95
47	TP84B	Wood Fertilizer Box with Cut Off Gate	\$ 139.95
51	TP87A	Box Steady Brace	\$ 7.95

OPENING SHOVEL

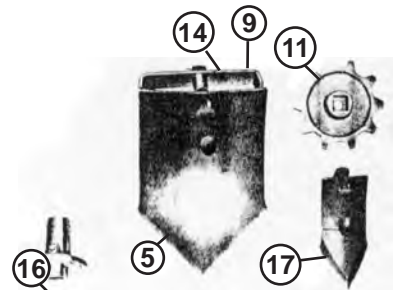

#	ORDER #	Description	Price
5	TP69	Opening Shovel 7" X 10"	\$ 41.95
9	TP70B	Spacer	\$ 3.95
10	TP70A	Yoke	\$ 6.95
11	C819	Sprocket 10 Tooth	\$ 23.95
14	TP29A	Bushing	\$ 3.50
16	TP29	Bearing	\$ 9.95
17	TP73	Point 2 1/2" X 6"	\$ 16.95

SINGLE GRAIN ATTACHMENT SHAFT ASSY

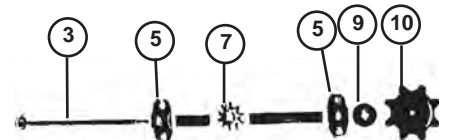

#	ORDER #	Description	Price
3	TP89	Shaft 7/16" SQ X 10"	\$ 9.95
5	TP1	Bearing	\$ 9.95
6	TP91B	Bushing	\$ 3.00
7	C804	Sprocket 10 T	\$ 9.95
8	TP91A	Bushing	\$ 3.50
9	TP32	Bushing	\$ 5.95
10	C818	Sprocket 8 T	\$ 16.95
11	TP333	Chain 5 Ft	\$ 49.95



SINGLE GRAIN ATTACHMENT BOTTOM C900A

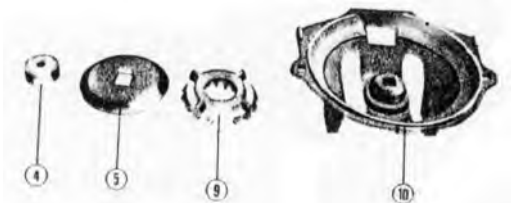

Ref #	ORDER #	Description	Price
4	C908	Cone Adjustment	\$ 7.95
5	TP910	Washer	\$ 16.95
9	C901	Gear 16 Tooth	\$ 14.95
10	C900	Bottom Grain Attachment	\$ 59.95

COVINGTON TP 3A SIDE DRESSER PARTS



ORDER #	Description	Price
TP84B	Wood Fertilizer Box With Gate	\$ 139.95
TP821P	Poly Fertilizer Box With Gate	\$ 219.95
D9	Cast Wheel	\$ 119.95
SD77	Fertilizer Spout (2 Required L&R)	\$ 18.95
SD79	Vibrating Pan Complete	\$ 50.95

SEED PLATES

Plate #	Cells	Description
TP540	2	Watermelon
TP904	4	Corn
TP907	6	Corn
TP905	8	Peanut
TP525	10	Pea, Corn Medium Flat
TP527	10	Corn Small Round Black Eye Pea, Okra Field Pea
TP528	10	Corn Medium Round
TP529	10	Corn Large Round
TP530	16	Soybean
TP531	16	Sorghum
TP532	16	Peanut Large
TP550	16	Sunflower
TP906	16	Peanut



12" OPENING DISC ASSY (1963 -)

TP692 Less Braces
(TP 50) And Spacer (TP 51)

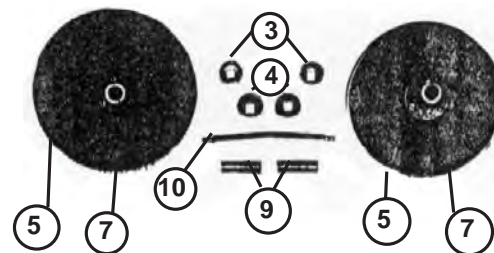

PRESSER WHEEL

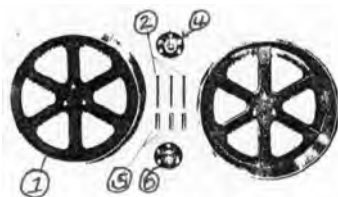

#	ORDER #	Description	Price
1	C845	Presser Wheel	\$139.95
2	BC8	Bolt Kit	\$ 7.95
4	TP30	Shaft Sprocket End	\$ 16.95
6	TP31	Shaft Plain End	\$ 16.95
5	TP57	Spacers	\$ 3.95

PLANTER CHAIN



FITS: Covington Planters
Approximately 5 Ft.
ORDER # TP333..... \$ 49.95

PLANTER HOSES

ID. At Top - 2"
OD. At Bottom - 1-1/2"
Minimum Length 10"
To Maximum 30".
ORDER # 110100..... \$ 18.95



ID. At Top - 1-1/4"
OD. At Bottom - 1-1/4"
Minimum Length 13" To Maximum of 31-1/2".
ORDER # TY201..... \$ 14.95

Ref #	ORDER #	Description	Price
3	TP514	Spacer	\$ 8.95
4	TP515	End Cap	\$ 8.95
5	TP19	Disc 12"	\$ 17.95
9	TP516	Bushing	\$ 3.95
10	TP49B	Axle	\$ 16.95
7	TP513	Bearing	\$ 20.95

COLE - POWELL 11 and 12MX PLANTER PARTS & MULTI-FLEX (HeHai) PLANTER PARTS

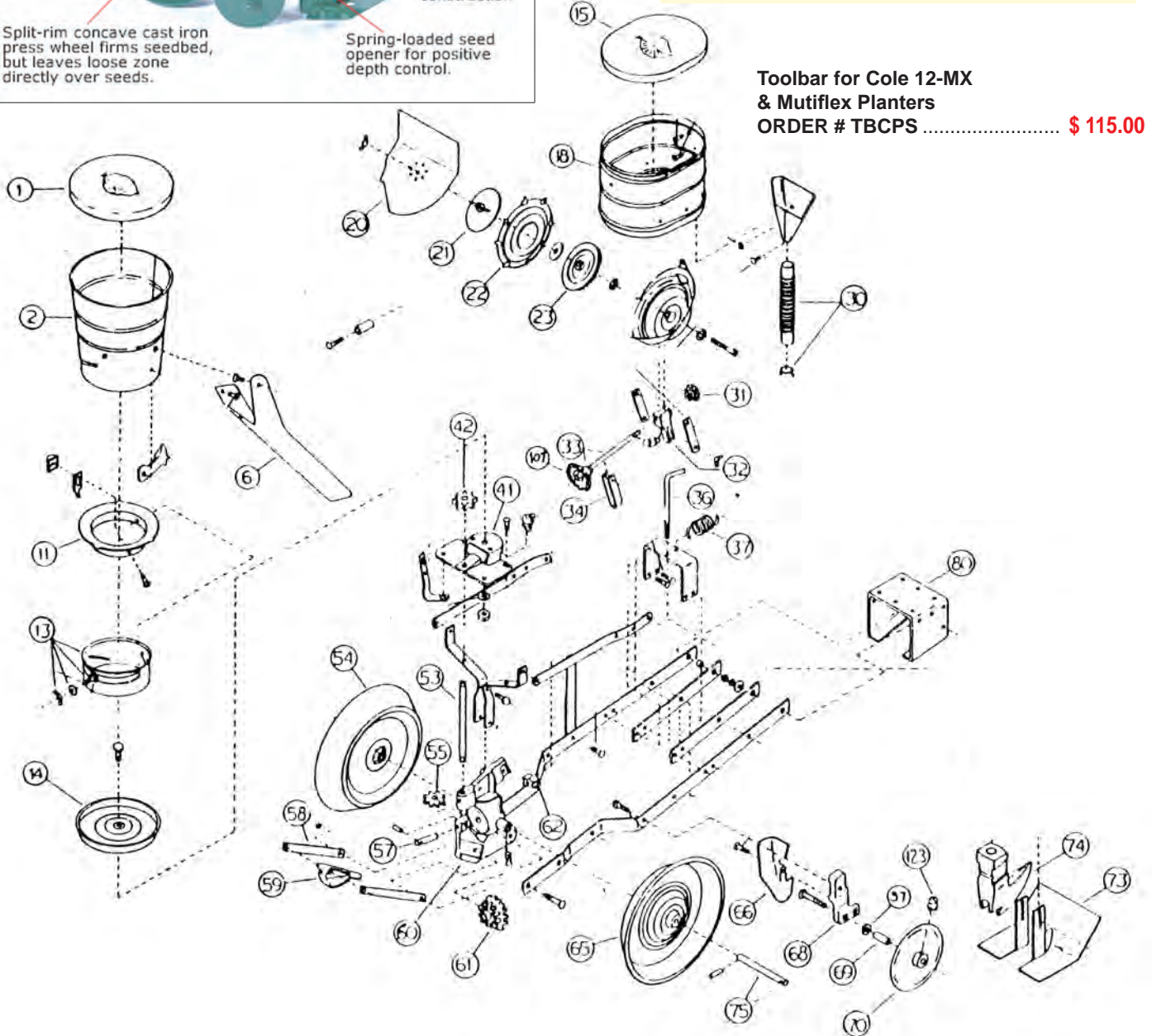
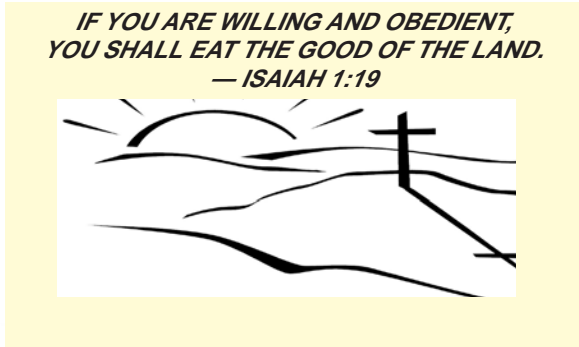
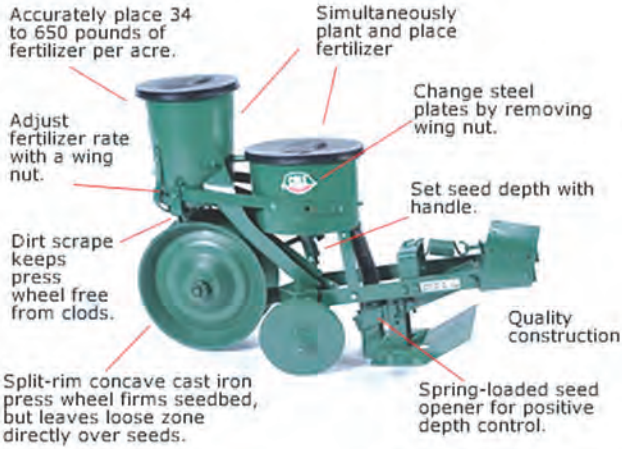

Toolbar for Cole 12-MX & Mutiflex Planters
ORDER # TBCPS \$ 115.00

COLE - POWELL 11 and 12MX PLANTER PARTS

COLE - POWELL - HEHAI SEED PLATES

Item #	Description	ORDER #	Price
1	Lid - Plastic - Fert. Hopper	20909	\$ 39.95
2, 11, 13	Fertilizer Hopper Assy	NS34	\$ 187.95
6	Fertilizer Spout	S35	\$ 32.95
14	Fertilizer Plate Assy	P00246	\$ 115.95
11	Fertilizer Ring	57	\$ 61.95
13	Cut Off Band Assy	S37	\$ 75.95
11 & 13	Fertilizer Ring & Band Assy	57S37	\$ 129.95
15	Seed Hopper Lid	21025	\$ 43.95
18	Seed Hopper	30592	\$ 56.95
20	Seed Partition	20927	\$ 22.95
21	Seed Plate Cap	20926	\$ 29.95
23	Gear Under Seed Plate	187	\$ 35.95
30	Rubber Spout & Wire	21104	\$ 25.95
31	Gear Specify # of Teeth		
	G8, G10, G12, G14	G8-14	\$ 31.95
32	Upper Bearing	206	\$ 37.95
33	Seed Hopper Shaft/Gear	CB45	\$ 84.95
34	Axle Stop	C43	\$ 34.95
36	Height Adjusting Rod	21132A	\$ 12.95
37	Spring	21108	\$ 32.95
41	Saddle	20512	\$ 45.95
42	Upper Drive Gear	B255	\$ 17.95
53	Drive Shaft	20713A	\$ 11.95
54	Cast Wheel - Half - Gear Side	186BG	\$ 159.95
55	Lower Drive Gear	20712	\$ 16.95
57	Axle For Drive Gear	20322	\$ 19.95
58	Brace	20630	\$ 12.95
59	Wheel Scrape	20720	\$ 29.95
60	Main Support	20320	\$ 149.95
61	Drive Gear	A253	\$ 29.95
62	Lower Bearing	A214	\$ 13.95
65	Cast Wheel - Half Plain Side	186BP	\$ 153.95
66	Side Placer Spout	21174	\$ 69.95
68	Bracket For Placer Spout	21175	\$ 34.95
69	Bushing	P20705	\$ 11.95
70	Covering Wheel (Coulter)	20697	\$ 109.95
73	Skid Plate	21109	\$ 54.95
74	Opener Foot	P21131	\$ 79.95
75	Axle 3/4" X 8"	S99	\$ 26.95
80	Machine Bracket	P21121	\$ 54.95
81	Shim Washer	001-1309	\$ 1.50

Vegetable Type	Cells	Planting Information	Plate #
Corn:			
Small Flat	12		PDX554
Medium Flat	12	Plants 1 per cell	X367
Large Flat	12		PDX566
Extra Small Round (including Popcorn)	18	Plants 1 seed per cell	X604
Small Round	18		X605
Medium Round	18	Plants 1 seed per cell	X606
Medium Flat	18		X613
Beans & Peas:			
Peas & Beans	8	Plants 3 to 7 per hill	P30435
Bush Beans	12	Plants 1 to 2 per cell	X334
Small Limas	32	Plants 1 per cell	X340
Large Snap Beans	36		X350
Soybeans, Field Peas, Small Sanp Beans	42	Plants 1 or 2 per cell	30433
Watermelon, Squash, Pumpkin			
	2	Plants 3 or 4 seeds per hill	PDX355
Cantaloupe, Cucumber			
	6	Plants 2 or 3 seeds per hill	POX362
Milo / Sorghum; also Okra, Tomato, Asparagus, Cane, Beets & similar seeds			
	16	Okra plants 1 or 2 per cell; Sorghum plants 2 to 3 per cell	30434
Milo / Sorghum; also Okra, Tomato, Asparagus, Cane, Beets & similar seeds	40	Plants 2 per cell	X343
Sunflowers			
	12		PDX636
Peanuts:			
Jumbo, Extra Large	16		X480
Medium	26	Picks up more than 1 per cell	X467



**All Seed Plates are \$ 42.95
except the X480 and the PDX563.
Those are \$ 49.95**

See our website for seed spacing information
Plates also available for small peanuts, cotton and drill seeds.

Auger Blades are priced per pair

AUGER BLADES & POINTS

DANUSER
with Serrated Edge



- FITS: 9"
ORDER # 1641211 \$ 39.95
- FITS: 12"
ORDER # 1641213..... \$ 52.95

INTERNATIONAL MACHINERY



- FITS: 6"
ORDER # PHDTIM6 \$ 29.95
- FITS: 9"
ORDER # PHDTIM9 \$ 29.95
- FITS: 12"
ORDER # PHDTIM12 \$ 29.95

SPEECO



- FITS: 6"
ORDER # PHDTSP6 \$ 21.95



- FITS: 9"
ORDER # PHDTSP9 \$ 21.95

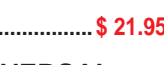

- FITS: 12"
ORDER # PHDTSP12 \$ 21.95

LEINBACH / UNIVERSAL



- FITS: 4"
ORDER # L51184..... \$ 45.95



- FITS: 6"
ORDER # L5118-6 \$ 45.95

- FITS: 9"
ORDER # L5118-9 \$ 45.95

- FITS: 12"
ORDER # L5118-12 \$ 49.95

UNIVERSAL AUGER POINTS

Danuser, Ford, Howse, Worksaver, Speeco and other units



- Screw Point with 1-1/4" - 7 male threads.
ORDER # 1641201 \$ 29.95



- Fish Tail Point with 1-1/4" - 7 male threads.
ORDER # 1641202 \$ 41.95



- Screw Point Solid Shaft with 1/2" hole Approximately 1-7/8" OD
FITS: Augers with 2" ID
ORDER # HP400 \$ 19.95

GOD is good all the time!!!

BOX BLADE SHANKS & POINTS

FITS: Big Bee Box Blades, Pasture Renovators and May Fit Others.
BACK Notched
ORDER # DHBBS \$ 29.95



Crimp On or Weld On Box Blade Point.
FITS: 3/4" Shanks. Made From Heat Treated Steel.
ORDER # 36802 \$ 6.95



FITS: Modern Box Blades, Dragon Products and May Fit Others.
FRONT Notched
ORDER # 4028287 \$ 39.95



SUBSOILER POINTS

These points are reversible and used on many single subsoilers.



FITS: All Box Blades Using Round Hole Shanks.
Shank With ROUND Holes.
ORDER # SBBS \$ 29.95



Heavy Duty Point
2-1/2" Wide
12" Long.
Holes Are 1/2" Sq. 2" on Center.
ORDER # SS7..... \$ 19.95

TILLER BLADES

We offer a LARGE selection of Tiller blades. Let us know your needs.



*"Humble yourselves therefore Under the mighty hand of God, that he may exalt you In due time".
— 1 Peter 5:6*

TOP LINKS

Top Link Pin Diameter Measurements

Category 0 - Up To 15HP	5/8 in.	Pin Hole Diameter
Category 1 - Up To 45HP	3/4 in.	Pin Hole Diameter
Category 2 - Up To 100HP	1 in.	Pin Hole Diameter



Forged Top Links

Adjustable at the center with rod included

Cat	Pin Hole	Body	Thread	Adjust	ORDER #	Price
0	5/8"	7-1/2"	3/4"	11" to 16"	15996	\$ 16.95
1	3/4"	9"		13" to 19" For Compact tractors	159114	\$ 23.95
1	3/4"	12"		15-3/4" to 23-3/4" For Compact tractors	159115	\$ 26.95
1	3/4"	16"		20-1/2" to 29" Most Common	159116	\$ 21.95
1	3/4"	20"		24" to 35"	159117	\$ 27.95
1	3/4"	24"		29" to 39"	JSA1024R	\$ 34.95
1 & 2	3/4" & 1"	12"		16" to 24"	JSA101212C	\$ 43.95
1 & 2	3/4" & 1"	16"		19-1/2" to 29-1/2"	JSA1200R	\$ 31.95
2	1"	16"	1-1/8"	21" to 33"	159201	\$ 31.95
2	1"	20"	1-1/8"	25" to 37"	159202	\$ 33.95
2	1"	24"		29" to 41"	JSA2024R	\$ 63.95
2	1"	16"	1-1/4"	23" to 32" Heavy Duty	TL173A	\$ 46.95
3	1-1/4"	19"	1-3/8"	25-1/2" to 36-1/2"	159301	\$ 79.95

WELD-ON REPAIR ENDS

Width of actual weld on part is 1-1/8".

Category 1
3/4" Hole.

ORDER # 159101..... \$ 6.95

Category 2
1" Hole.

ORDER # 159102..... \$ 9.95

WELD-ON BALL JOINTS

Cat	Pin Hole Size	ORDER #	Price
0	5/8"	1592226	\$ 7.95
1	3/4"	159213	\$ 9.95
2	1"	159214	\$ 11.95
3	1-1/4"	1592229	\$ 23.95
1 & 2	3/4", 1"	159236	\$ 16.95

JOHN DEERE TOP LINK BALLS

Category 1 (1-3/4" Wide)
3/4" Hole For 2" Round Socket.

ORDER # SF2680R \$ 5.95

Category 2.
1" Hole For 2" Round Socket

ORDER # SF2681R \$ 5.95

CASE / IH TOP LINK PINS

Cat. 1 3/4" X 3" (1-3/4" Shoulder).
ORDER # 150111 \$ 6.95

Cat. 2 1" X 4" (1-5/16" Shoulder).
ORDER # 150110 \$ 8.95

TOP LINK BUSHINGS

	OD	ID	Length	ORDER #	Price
For Category 1 Tractor & Category 0 Implement	3/4"	5/8"	1-5/8"	159829	\$ 1.50
For Category 2 Tractor & Category 1 Implement	1"	3/4"	2"	159832	\$ 2.00
For Category 3 Tractor & Category 2 Implement	1-1/4"	1"	2"	159833	\$ 2.50

TOP LINK PINS

Cat.	Pin Dia	Usable Length	Overall Length	ORDER #	Price
0	5/8"	3"		150776	\$ 2.25
1	3/4"	2-3/4"	4-1/2"	1504	\$ 1.95
1	3/4"	3-7/8"	5-5/16"	15012	\$ 1.95
1	3/4"	4-3/4"		1501464	\$ 2.25
2	1"	3-5/8"	5-5/16"	1501674	\$ 4.50
2	1"	5-3/8"	6"	1501892	\$ 4.95
3	1-1/4"	4-11/16"		1507711	\$ 9.50

TOP LINK REPAIR ENDS



Cat	Ball ID	Thread	ORDER #	Price
0	3/4"	5/8" RH	TL01R	\$ 14.95
0	3/4"	5/8" LH	TL02L	\$ 14.95
1	3/4"	1" RH	TL501R	\$ 21.95
1	3/4"	1" LH	TL502L	\$ 21.95
1	3/4"	1-1/8" RH	JSA1111	\$ 11.95
1	3/4"	1-1/8" LH	JSA1112	\$ 11.95
2	1"	1-1/8" RH	JSA2221	\$ 14.95
2	1"	1-1/8" LH	JSA2222	\$ 14.95
2	1"	1-1/4" RH	RE1718R	\$ 22.95
2	1"	1-1/4" LH	RE1717L	\$ 22.95

LINKAGE - THREE POINT HITCH

LOWER LIFT ARMS & RELATED PARTS

Helpful Information

Category 1 and 2 are used to classify tractors by drawbar horsepower. See the table below. Category sometimes will be abbreviated through the catalog as Cat.

Maximum Drawbar Horsepower	Lift Arm Pin Diameter	Standard Lift Arm Spacing
Category 0 - Up To 15	5/8 in.	20 in.
Category 1 - Up To 45	7/8 in.	26 in.
Category 2 - Up To 100	1-1/8 in.	32 in.

UNIVERSAL LOWER LIFT ARM

Universal Lift Arm.

Constructed of Heavy Steel 1/2" x 2 1/2".

FITS Cat 1 pins,

A = 31-9/16" Hole Centers. B = 15-7/8"

For Models Ford 2N, 8N, 9N, NAA,

Ferguson Models, MF35, 50, John Deere 1010

ORDER # 9N555C \$ 49.95

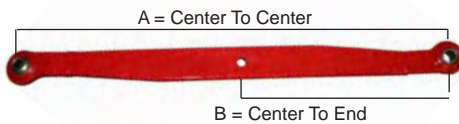

LOWER LIFT ARMS

Lift Arms for Small Compact Diesel Tractors

All Arms Below are 2-1/2" Wide - 5/8" Thick, & Category 1 Please Check All Measurements Before Ordering.

Several Sizes Below To Choose From

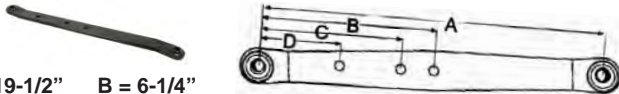

A = 19-1/2" B = 6-1/4" ORDER # 159322..... \$ 29.95

A = 21-1/2" B = 9-1/4" C = 7-1/4" ORDER # 159324..... \$ 32.95

A = 23-1/2" B = 13-3/4" C = 12" D = 8-1/2" ORDER # 159326 \$ 39.95

A = 25-1/2" B = 14-3/4" C = 13" D = 8-1/2" ORDER # 159328 \$ 49.95

A = 27-1/2" B = 16" C = 13" D = 6" ORDER # 159330 \$ 49.95

A = 29-1/2" B = 15-1/2" C = 11-3/4" D = 6" ORDER # 159332..... \$ 49.95

LIFT ARM PINS

Designed for Most Compact Diesel Tractors 15 to 40 HP

(A) 3/4" Pin Dia, (B) 1-11/16" Usable Length, (C) Overall Length is 3-9/16" with 7/16" Thread Dia.

ORDER # 15011 \$ 4.95

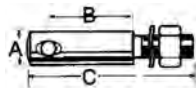

(A) 3/4" Pin Dia, (B) 1-5/8" Usable Length, (C) Overall Length is 4-5/16" with 5/8" Thread Dia.

ORDER # 15013 \$ 5.95



LOWER LIFT ARM PINS

Fixed Shoulder Type Pin						
Category	Pin Dia.	Usable Length	Overall Length	Thread Dia	ORDER #	Price
1	7/8"	1-3/4"	5-1/2"	7/8"	15010	\$ 3.25
1	7/8"	2-1/4"	6-1/2"	7/8"	1501677	\$ 4.95
2	1-1/8"	1-3/4"	6-5/16"	1-1/8"	150720	\$ 6.50
1 to 2	7/8"	2-3/8"	6-3/8"	1-1/8"	150730	\$ 5.95
2 to 1	1-1/8"	1-3/4"	5-1/4"	7/8"	1507	\$ 5.95
2 to 1	1-1/8"	2-1/4"	6-5/16"	7/8"	1501678	\$ 6.95

Adjustable Nut Type Pin						
Category	Pin Dia.	Usable Length	Overall Length	Thread Dia	ORDER #	Price
0	5/8"	1-5/16"	3-7/8"	5/8"	1507220	\$ 3.95
1 to 0	7/8"	1-3/4"	4-1/2"	5/8"	P7221	\$ 5.50
1	7/8"	1-3/4"	5-5/16"	7/8"	P2009	\$ 3.95
1 to 2	1-1/8"	1-3/4"	5-3/16"	7/8"	150724	\$ 5.95
2	1-1/8"	1-3/4"	6-1/4"	1-1/8"	150721	\$ 5.95

LOWER LIFT ARM REDUCER BUSHINGS

Category	OD	ID	Length	ORDER #	Price
1 to 0	7/8"	5/8"	1-3/8"	159828	\$ 2.00
2 to 1	1-1/8"	7/8"	1-3/4"	159821	\$ 2.00
3 to 2	1-7/16"	1-1/8"	1-3/4"	159832	\$ 2.25
3 to 2	1-7/16"	1-1/8"	2-3/4"	1592164	\$ 3.50
3 to 2	1-7/16"	1-1/8"	3-1/4"	159824	\$ 3.50

LIFT ARM WELD-ON REPAIR ENDS

Forged Universal Weld-On Ends With Ball Joint. Repairs Any Lower Arm. Priced Each

CAT 1. ORDER # 1591338 \$ 11.95
 CAT 2. ORDER # 1591342 \$ 14.95
 CAT 3. ORDER # 1591344 \$ 26.95



LIFT ARM WELD-ON BALL JOINTS

FITS: CAT. 1, 7/8" Bore
 ORDER # 159221..... \$ 11.95

FITS: CAT. 2, 1-1/8" Bore
 ORDER # 159222..... \$ 16.95



COMBINATION BALL SOCKETS CATEGORY 1 & 2

Socket Has 1/4" Thick Race. - For Light Arms
 ORDER # 159232..... \$ 19.95

Socket Has 7/16" Thick Race - For Heavy Duty Arms
 ORDER # 159234..... \$ 22.95



HITCH PARTS

Quick Hitch Bushing Kit

works with 3-pt Quick Hitches.
Includes two bushings and two roll pins.
The shoulder on bushing helps to guide the implement while hooking-up.

Sold as a set of 2 with roll pins

Catagory 1 7/8" ID ORDER # 162100 \$ 24.95
Catagory 2 1-1/8" ID ORDER # 162200 \$ 24.95



PAT'S EASY HITCH PARTS

Bent Washers

Sold as a pair

Catagory 1 (7/8") ORDER # EHWB \$ 4.95
Catagory 2 (1-1/8") ORDER # EHWB2 \$ 4.95



Hitch Arm Pin

Sold Individually (For one side)

Catagory 1 (7/8") ORDER # EHSP1 \$ 4.95
Catagory 2 (1-1/8") ORDER # EHSP2 \$ 4.95

Easy Hitch Latch & Spring Kit

Sold Individually (For one side)
For Catagory 1 or 2 Hitches

ORDER # EHSK \$ 8.95



DRAW PINS

Cat	Pin Dia	Usable	ORDER #	Price
1	7/8"	3-3/4"	873-3149	\$ 4.95
2	1-1/8"	4-3/4"	P7236	\$ 5.95
2	1-1/8"	9"	873-3132	\$ 11.95



HITCH PINS

Forged from high carbon steel. Zinc Plated Handle And Pin. Forged shoulder, a super strong pin with a smooth finish. Includes Hair Pin Clip.



Pin Dia	Length	ORDER #	Price
5/8"	4-1/2"	156158	\$ 3.95
5/8"	5"	P6255	
5/8"	6"	1561586	\$ 4.25
3/4"	4-1/2"	156134	\$ 4.95
3/4"	5-1/4"	P7505	\$ 4.95
3/4"	6"	1561346	\$ 5.25
7/8"	4-1/4"	P8754	\$ 4.95
7/8"	6"	1561786	\$ 5.95
1"	4-3/4"	P1004	\$ 6.95
1"	6-3/4"	P1006	\$ 7.95
1-1/8"	7"	P1125	\$ 10.95

DRAWBARS & RELATED PARTS

Catagory 0

Welded High Carbon Steel Drawbar.

2" Wide, 5/8" Thick,
20" Usable Length,
5/8" Pin Dia. Seven 5/8" Holes

ORDER # 159418..... \$ 27.95



Catagory 1

Standard Duty One Piece High Carbon Steel Drawbar.

2-1/2" Wide, 1" Thick,
26" Usable Length,
7/8" Pin Dia., Eleven 3/4" Holes

ORDER # 159411..... \$ 37.95



Heat Treated, 7 Hole Drawbar.

FITS All Tractors With 20" Lift Arm Spacing
2-1/2" Wide, 1" Thick.
20" Usable Length,
7/8" Pin Dia, Seven 3/4" Holes.

ORDER # 159419 \$ 31.95

Catagory 2

Standard Duty One Piece High Carbon Steel Drawbar

3" Wide, 1-1/4" Thick,
32" Usable Length,
1-1/8" Pin Dia, Thirteen 3/4" Holes

ORDER # 159422 \$ 59.95



Short One Piece High Carbon Steel Drawbar

3" Wide, 1-1/4" Thick,
26" Usable Length.
1-1/8" Pin Dia, Eleven 3/4" Holes

ORDER # 159421 \$ 50.95

DRAW BAR LOCK

FITS: Standard Cat 1 Drawbar

Simply Slips Over Drawbar And Tractor Lift Arm. Prevents Drawbar From Rotating. Comes With Bolt & Nut

ORDER # CDBL..... \$ 23.95



You are forgiving and good, O LORD, abounding in love to all who call to you. — Psalm 86:5

DRAW BAR "A" FRAME

Simply Bolts To Standard Cat 1 DrawBar. Prevents DrawBar From Rotating. Great For Pulling Trailers, Attaching Plows, Etc... Boxed With Bolts.

Drawbar NOT INCLUDED.

ORDER #DBAF \$ 39.95

Complete Kit With DrawBar (159-411)

ORDER #DBAFDB \$ 66.95



BAR STABILIZER KIT

Universal Category 1 Three Point Hitch Stabilizer Kit. 31-1/2" Hole Spacing. Contains Items Pictured Above.



FITS: Ford Tractors 8N, 9N, 600, 800, 2000 & 4000. 4 Cyl. Models (1939 - 1964)
 FITS: Massey Ferguson Tractors TO20, TO30, TO35, F40, MH50, MF50
ORDER # SK100..... \$ 52.95

STABILIZER COMPONENTS

FITS: Right Hand & Left Hand

Link Or Arm Only
ORDER # SA621..... \$ 14.95



Universal Bracket For Both LeftHand And Right Hand Sides
ORDER # 159631..... \$ 13.95



STABILIZER PINS

For Standard Stabilizer Arms. Pin Dia. 7/8", Thread Dia. 5/8" Usable Length 1/4" Overall Length 2-1/2"
ORDER # 230044WNL..... \$ 2.25



For Stabilizer Arms Pin Dia. 7/8", Thread Dia. 5/8" Usable Length 1" Overall length 3".
ORDER # 15014..... \$ 3.50



ADJUSTABLE STABILIZER ARM

Heavy Duty. Closed 27 1/2". Extends to 35". Arm Assembly Complete With Both Ends Assembled. FITS: All Kits
ORDER # 159628..... \$ 21.95



LH End Only 7/8" Fine Thread. Round Tractor End, 7/8" Hole
ORDER # P1476..... \$ 9.95



RH End Only 7/8" Fine Thread. Drawbar End, 7/8" Hole
ORDER # P1477..... \$ 9.95



Three Point Hitch Diagram (For Reference)

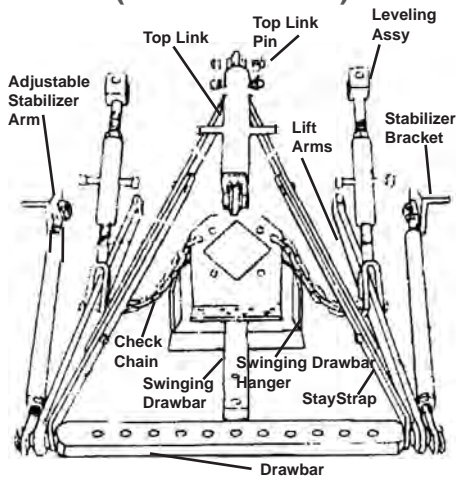

CHAIN STABILIZER KIT

Category 1. Chain Stabilizers. Turnbuckle And Chain Links Adapt To Any Size Three-Point. Move Clevis Up OR Down Chain Links; Use Turnbuckle For Final Adjustment.
Sold In Pairs
ORDER # SK102CH..... \$ 59.95



CHAIN STABILIZER KIT PARTS

Clevis	ORDER # SK102CHCL	\$ 6.95
Center Tube	ORDER # SK102CHCT	\$ 16.95
EyeBolt LH	ORDER # SK102CHEBL	\$ 8.95
EyeBolt RH	ORDER # SK102CHEBR	\$ 11.95
Nut	ORDER # SK102CHN	\$.95
Clevis Pin	ORDER # SK102CHPN	\$ 6.50
6 Link Chain	ORDER # SK102CHCH	\$ 14.95

CHAIN LIMITER KIT

Heavy Duty 1/4" Hi- Test Chain Category 1

Complete With Chains And Brackets
 Fastens To Tractor Top Link Pin, Chain Holders Slips Over Implement Pin Cat. 1. Hook Chains Through Chain Bracket. Set Implement To Desired Height. Maintains An Even Height, Takes Strain Off Hydraulic Lift. Great For Tractors With A Weak Lift. Heavy Duty with 1/4" x 30" Hi Test Chain
ORDER # CLK..... \$ 32.95



ADJUSTABLE STABILIZERS

Adjusts From 22" to 24-3/8"
 FITS: Compact Tractors
ORDER # SBA370500930..... \$ 59.95



A = 10-1/4"
 C = 90 Degrees
 D = 1/2"
 E = 16mm X 1.5
 FITS: Compact Tractors
ORDER # CTS70633..... \$ 30.95

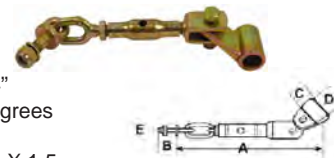

CHECK CHAIN STABILIZERS

Designed for Most Compact Diesel Tractors 15 to 40 HP

Turnbuckle Measures 3-1/2" Overall Length 13"
 3 links of 3/8" Chain. Comes With Nut and Lockwasher. Round Body Style.
ORDER # 159350..... \$ 24.95



Turnbuckle Measures 4-1/4" Overall Length 25-1/2"
 10 Links of 7/16" Chain. Comes With Lockwasher and Nut. Square Body Style.
ORDER # 159425..... \$ 26.95



ADJUSTABLE STABILIZER

Adjusts from 18" to 23-1/2"
 FITS: Kubota M Series and Many Other Models.
ORDER # D9NNB856B..... \$ 69.95



STABILIZER BARS

Adjustable

Stabilizer Bar Short Red Bar
 FITS: Many Models
 A = 7/8" (12 Degrees)
 B = 9-5/8" C = 15" Min
ORDER # CTS00185..... \$ 27.95



Short Zinc Bar
 FITS: Many Models
 A = 7/8" B = 6"
 C = 16" Min
ORDER # CTS00173..... \$ 19.95



LEVELING BOXES & SIDE LINKS - LEVELING RODS

ADJUSTABLE SIDE LINKS

These Adjustable Side Links are Designed For Compact Diesel Tractors

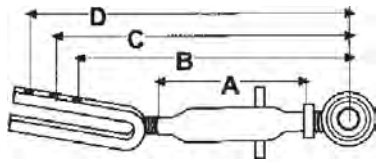

Three Sizes Below To Choose From
Ball Joint Hole Size is Cat. 1

A = 7-1/2" Center Tube
B = 13"
C = 14"
D = 15" Center To Center
ORDER # 159750 \$ 29.95

A = 9-1/2" Center Tube
B = 15-1/2"
C = 16-1/2"
D = 17-1/2" Center To Center
ORDER # 159950 \$ 29.95

A = 11-1/2" Center Tube
B = 15-3/4"
C = 16-3/4"
D = 17-3/4" Center To Center
ORDER # 1590115 \$ 34.95

ADJUSTABLE SIDE LINK

Ball Joint Hole Size is Cat. 0

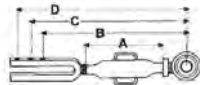

A = 7-1/2" Center Tube
B = 13"
C = 14"
D = 15"
FITS: Most Compact Diesel Tractors Using Category 0.
ORDER # 15990 \$ 29.95

ADJUSTABLE LEVELING BOX

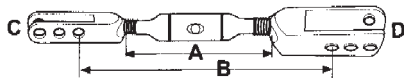

A = 5-1/2"
B = 10-7/16"
C = 7/8"
D = 1-21/32"
FITS: Compact Diesel Tractors
ORDER # CTS70638 \$ 36.95

The world has forgotten, in its concern with Left and Right, That there is an Above and Below

LEVELING ROD - LH NON-ADJUSTABLE

These Leveling Rods are Designed For Compact Diesel Tractors

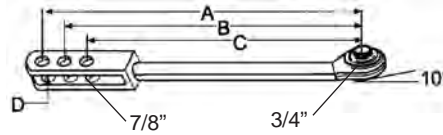

Three Sizes Below To Choose From
Ball Joint Hole Size is Cat. 1

A = 15-3/4"
B = 14-1/4"
C = 12-3/4"
D = 9/16"
ORDER # 159975 \$ 19.95

A = 17-3/4"
B = 16-3/4"
C = 15-3/4"
D = 9/16"
ORDER # 1591150 \$ 19.95

A = 23-5/8"
B = 21-7/8"
C = 20-3/8"
D = 9/16"
ORDER # 159155 \$ 29.95

NON - ADJUSTABLE LEVELING ROD - LH

FITS: Compact Diesel Tractors LH - Non-Adjustable Center to Center Measures 11-5/8". 15mm Pin Hole Size
ORDER # CTS70635 \$ 32.95

TURNBUCKLE JACK

Replaces Most Standard Hydraulic Cylinders. Adjusts From 20" Closed To 28" Open. Safety Design Prevents Ends From Being Accidentally Threaded Out Of Body.
1 1/4" NC Threads. 1" Clevis Pins, Clips And Handle Included.
ORDER # 1591541 \$ 54.95

UNIVERSAL LEVELING ASSY

Replaces Many Expensive Leveling Arms. 18 1/2" Closed, 25" Open Length, 7/8" NF Thread. Sturdy Clevis With 5/8" Hole at Each End. May be used right or left.
ORDER # 159152 \$ 29.95

LEVELING ASSEMBLY



Lift Arm Leveling Assembly Replaces many expensive leveling assemblies. Closed 17-3/4", Open Length 25" with 7/8" NF thread. 5/8" hole at one end, 3/4" swivel ball at top end. May be used right or left side. Application small compact tractors Kubota, Yanmar, others.
ORDER # 1590115 \$ 34.95

TURNBUCKLES

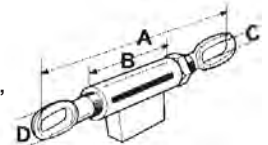

A = 9-5/8" - 13-1/8"
B = 4-3/4"
C = 1-3/8"
ORDER # CTS13266 \$ 18.95

A = 9-7/8" - 13-3/4"
B = 5-5/16"
C = 1-1/2"
ORDER # CTS13267 \$ 19.95

A = 10-7/8" 14-9/14"
B = 5-1/8"
C = 1-1/2"
ORDER # CTS13268 \$ 20.95

A = 11" - 15-3/8"
B = 5-7/8"
C = 1-1/2"
ORDER # CTS13269 \$ 21.95

LINCH PINS



Pin Dia	Length	ORDER #	Price
3/16"	1-3/8"	1541700	\$.50
1/4"	1-3/4"	1541600	\$.50
5/16"	1-3/4"	1542709	\$.50
7/16"	1-3/4"	DKLP91	3/\$1.00
7/16" HD	1-3/4"	1541924	\$.75
7/16" With Chain		DKPWCH	\$ 2.00

HAIR PIN ASSORTMENT

15-Piece Assortment In Plastic Container. Includes 4 Of Hp-3, 4 Of Hp-4, 4 Of Hp-5, And 3 Of Hp-6
ORDER # HPA15X \$ 7.50

HYDRAULIC CYLINDERS & SEAL KITS

OUR BEST SELLER

FEATURES:

- 2500 PSI Working Pressure (4000PSI Max.Shock)
- Precision honed cylinder barrels for long seal life
- Hardened chrome plated rods resist damage and rust
- Rod Wipers clean dirt from rod to give long seal life
- Clevis mounting with 1" pin holes on 2" thru 4" bore sizes: 1-1/4" pin holes on 5" bore
- Ports in line pins

Bore 2"
Stroke 8"
Rod Dia. 1-1/8"
Closed Length 20-1/4"
Pin Dia. 1"
ORDER # 263-2088 \$109.95



Bore 3"
Stroke 8"
Rod Dia. 1-1/4"
Length 20-1/4"
Pin Dia. 1"
ORDER # 2603288..... \$119.95



Bore 3"
Stroke 12"
Rod Dia. 1-1/4"
Closed Length 22-1/4"
Pin Dia. 1"
ORDER # 263-3212 \$149.95

CYLINDER REPAIR KITS

For Cross, Hydroline And Sanborn.
 May Fit Other Of Same Size

Bore	ORDER #	Price
2"	1C4244	\$ 17.95
2 1/2"	1C4433	\$ 19.95
3"	1C4629	\$ 21.95
3 1/2"	1C4429	\$ 24.95



HYDRAULIC CYLINDER STROKE CONTROL SPACERS

Easy to open and snap on shaft.

For 1-1/8" to 1-1/2" size shafts
 4 pc Cast Aluminum set
 contains 3/4", 1", 1-1/4", 1-1/2" widths.
ORDER # 2651 \$ 24.95

For 1-1/4" size shaft
 5 pc Cast Iron set
 contains: (2) 1", (1 each of 1-1/4",
 1-1/2" & 1-3/4" widths).
ORDER # 2652 \$ 25.95

HYDRAULIC TOP LINK CYLINDER & HOSE KIT

The Top Link Cylinder Allows For Control Of Top Link Adjustment From The Tractor Seat. Fits Most Cat II. Tractors And Implements. Ideal For Bale Movers, Blades, Post Drivers And Quick Hitches.

SPECIFICATIONS:

- 3" Bore, 10" Stroke
- 20-1/2" Closed Dimension
- 1-1/4" Hard Chrome Plated Rod
- 1/2" NPT Ports
- 3000 P.S.I. Operating Pressure
- 1" Pin Openings On Both Ends



Top Link Cylinder
ORDER # 260188..... \$199.95

Hose Kit Consist Of
 1 - Hose 1/2" X 24" H422M24
 1 - Hose 1/2" X 36" H422M36
 2 - Swivel Fittings 60UA-08X08
 2 - Male Tips # 8010-4
ORDER # HTLHK \$ 59.95

More Top Link Cylinders available
 Call Today or Visit our website

LIQUID FILLED GAUGES

Gauges filled with liquid provide effective dampening of most pulsation and vibration and provide lubrication of all moving parts. These gauges require no dampening device. 2-1/2" diameter case, 1/4" MPT brass inlet.



2000 Lb
ORDER # GG2000 \$ 11.95
3000 Lb
ORDER # GG3000 \$ 11.95
5000 Lb
ORDER # GG5000 \$ 11.95

For 1-3/8" to 1-1/2" size shafts
 4 pc Aluminum set
 contains 1", 1-1/4", 1-1/2", 1-3/4" widths.
ORDER # 2653 \$ 26.95

For 1-3/4" to 2" size shafts
 4 pc Cast Aluminum set
 contains 1", 1-1/2", 2" & 4" widths.
ORDER # 2655 \$ 49.95



BREAK - AWAY CLAMPS

Designed for use with any female bodies that have 1-1/2" Diameter sleeves. These have heavy duty yoke & mounting bar for long service life.



Double Break-Away
Replaces 5006-4-10
ORDER # 5006-4 \$ 23.95

DUST PLUGS

Dust Caps and Plugs Keep Dirt Out Of The Equipment When Coupler Halves Are Disconnected.

Metal Plug
 For All 1/2, 3/4 -16
 And 7/8-14 Series
ORDER # 50054..... \$ 11.95

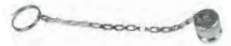

Rubber Plug
 For All Series
 Except 4100
ORDER # 52054..... \$ 4.95



DUST CAPS

Rubber
 For 4000 Series:
 1/2", 3/4" NPT; 3/4"-16,
 7/8"-14 & All 4200, 5000, 7000,
 8000, 8200
ORDER # 52094..... \$ 3.95



PIONEER TIPS

The Standard Male Tip of the Agricultural Industry, Developed and Proven by Pioneer in over 30 years of Farm Service. It has Rugged, Reliable Ball Valve and Induction Hardened Locking Ball Groove to Prevent Brinelling and Prolong Life. 8010 Series Male Tips Meet ASAE, SAE, and ISO Standardization Requirements.

Ball Type Tip
1/2" NPTF
ORDER # 80104..... \$ 7.95



Poppet Type Tip
 Ultimate in Preventing Leaks.
1/2" NPTF
ORDER # 80104P \$ 11.95



*The LORD lives!
 Blessed be my rock!
 May God, the rock of my
 salvation, be exalted!*

— 2 Samuel 22:27

ADAPTORS

Forged Adaptor

1-1/8" Female
(6 Spline) to
1-3/8" Male (6 Spline)
3" Length.
Extends PTO by 1-1/8"
ORDER # T318 \$ **16.95**



Roll Pin

5/16" X 1-1/16"
For T318 Adaptor Above
ORDER # T318RP \$ **.50**



EXTENSION ADAPTORS

For Tractors Up To 75 P T O HP

1-1/8" Female
(6 Spline) to
1-3/8" Male
(6 Spline), 5-1/2" Long.
Extends PTO by 3-9/16" with extra
cross pin hole for Ford.
For Universal Application
ORDER # T353F \$ **23.95**



1-3/8" Female (6 Spline) to
1-3/8" Male (6 Spline), 6-1/2"
Long. Extends PTO 4-9/16"
ORDER # T371 \$ **20.95**



P T O LOCK PINS

Lock Pin,
5/16" X 2-1/2"
Useable Length. (Square).
Replaces Bolt & Cotter Pins
ORDER # P7939 \$ **1.00**



Lock Pin,
5/16" X 2-1/2"
Useable Length. Replaces
Bolt & Cotter Pins
ORDER # P7940 \$ **1.00**



QUICK DISCONNECT PIN

Pin Kit To Repair
ALL American Series
Quick Detach Yokes
Includes:Pin, Spring
And Pin Clip
ORDER # QDK1 \$ **4.50**



SLEEVE TYPE ADAPTOR

1-1/8" Female
(6 Spline) to
1-3/8" Male (6 Spline)
2-1/4" Length.
For ALL Tractors
ORDER # T352 \$ **9.95**



Same As T352
Except 2" Long
ORDER # T363 \$ **28.95**

31/32" Female
(10 Spline) to
1-3/8" Male (6 Spline)
2 -1/4" Length.
For IHC Cub & Kubota
ORDER # T355 \$ **62.95**



*When grace happens,
Christ enters.
Christ in you, the hope of glory.
— Colossians 1:27*

SPLINED SLEEVES

1" ID - 6 Spline
1-3/8" OD
2-1/4"Length
ORDER # S341 \$ **23.95**



1-3/8" ID - 6 Spline
1-3/4" OD
3-3/4" 3/4" Length
ORDER # S345 \$ **66.95**

OVER - RUNNING COUPLERS

**Heavy Duty Couplers
For Tractors Up To 75 HP**

Free - Wheel Smoothly
When Implement Exceeds
P T O Speed.1000 R P M
Maximum Recommended
Operating R.P.M.



1-3/8" Female (6 Spline) to
1-3/8" Male (6 Spline)
ALL Including FORD
ORDER # C660F..... \$ **52.95**

1-1/8" Female (6 Spline) to
1-3/8" Male (6 Spline),
ALL Including Ford
ORDER # C670F..... \$ **50.95**



1-3/8" Female
(6 Spline) to
1-1/8" Male (6 Spline)
ALL Including Ford
ORDER # C680F..... \$ **69.95**



1-1/8" Female (6 Spline) to
1-1/8" Male (6 Spline)
ALL Including Ford
ORDER # C690F..... \$ **59.95**



ROLL PINS

Special Roll Pin Used To
Attach P T O Overrunning
Coupler To Tractor
Shaft. 5/16" Dia. X 2" Length .
Priced Per ONE Pin.
ORDER # RP2016..... \$ **.75**



QUICK DISCONNECT OVER - RUN CLUTCH

Quick Release Type
No more roll pins to install.
Used on Tractors up to 70HP
Extends PTO by approximately 4"

1-1/8" - 6 Spline
to **1-3/8" - 6 Spline.**
ORDER # 32439..... \$ **124.95**

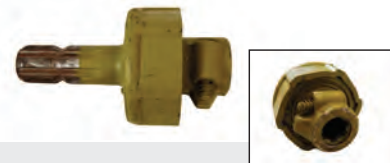

1-3/8" - 6 Spline
to **1-3/8" - 6 Spline.**
ORDER # 31949..... \$ **89.95**



GREASE FITTING ASSORTMENTS

One Dozen Of The Most Popular Grease Fittings Packed In Plastic Tubes.



Each Individual Pack Contains:

- 3 - 1/8" Straight
- 3 - 1/4" Straight
- 2 - 5/16" Straight



1ea of 1/8" & 1/4" 45 Degrees
1ea of 1/8" & 1/4" 90 Degrees

Standard ORDER # RGF12..... \$ 9.95

Each Individual Pack Contains:

- 2ea of 6, 8 & 10mm Straight
- 1ea of 6, 8 & 10mm 45 Degrees
- 1ea of 6, 8 & 10mm 90 Degrees



Metric ORDER # RMGF12..... \$ 10.95

SQUARE KEY STOCK

Comes In 12" Lengths



- 1/8" ORDER # 6522..... \$ 2.95
- 3/16" ORDER # 6523..... \$ 2.95
- 1/4" ORDER # 6524..... \$ 4.50
- 5/16" ORDER # 6525..... \$ 4.95
- 3/8" ORDER # 6526..... \$ 6.95
- 1/2" ORDER # 6528..... \$ 9.95
- 5/8" ORDER # 65210..... \$ 11.25

COTTER PIN ASSORTMENT

Assortment Of 100 Large Heavy Duty Cotters For Farm Machinery. Attractive Plastic Visual Container. ORDER # AG100..... \$ 8.95



HAIR PIN ASSORTMENT

Contains 15 Most Popular Hair Pins In Plastic Container. ORDER # HPA15X..... \$ 7.50



ROLL PIN ASSORTMENT

315 Piece Assortment of popular pins which assure the user a right pin when needed. ORDER # RPA90..... \$ 24.95



If anyone loves Me, he will obey My teaching. My father will love him, and we will come to Him and make our home with Him.
— John 14:23 NIV

ROLLER CHAIN

Import - Sold In Boxes Of 10 Foot



Order By Chain # **SINGLE STRAND**



Chain No.	Pitch	Price	Conn. Link	Offset Link
35RC	3/8"	\$ 21.00	\$ 1.70	\$ 2.20
40RC	1/2"	\$ 21.00	\$ 1.25	\$ 2.20
41RC	1/2"	\$ 21.00	\$ 1.65	\$ 2.90
50RC	5/8"	\$ 28.00	\$ 1.65	\$ 2.60
60RC	3/4"	\$ 40.00	\$ 1.80	\$ 2.60
80RC	1"	\$ 73.00	\$ 3.25	\$ 6.50

NOTE: When Ordering Connecting OR Offset Links Please Specify

EXTENDED PITCH CHAIN

Import - Sold In Boxes Of 10 Foot
Order By Chain #



Chain No.	Pitch	Price	Conn. Link Price	Offset Link Price
2040RC	1"	\$ 17.50	\$ 2.00	\$ 3.60
2050RC	1 1/4"	\$ 24.00	\$ 2.80	\$ 3.30
2060RC	1 1/2"	\$ 35.00	\$ 2.75	\$ 4.90

ROLLER LINKS

Chain No.	Pitch	Price
35RL	3/8"	\$ 1.05
40RL	1/2"	\$ 1.20
41RL	1/2"	\$ 1.90
50RL	5/8"	\$ 1.60
60RL	3/4"	\$ 2.00
80RL	1"	\$ 4.75
2040RL	1"	\$ 2.10
2050RL	1 1/4"	\$ 2.50
2060RL	1 1/2"	\$ 2.90



TOOLS FOR ROLLER CHAIN

Extractor Tool For Speedy Dismantling of Roller Chain.

For Chain Up To # 60
ORDER # CD316..... \$ 26.95



For Chain # 60 Up To # 100
ORDER # CD317..... \$ 41.95



CHAIN REPAIR TOOL

Like Having an Extra Hand
Chain Puller Tool
For Repairing # 35 Thru # 60 Chain
ORDER # CPT1..... \$ 12.95



TRACTOR FUNNEL

New Multi - Fit Lock On Funnel.



- Eliminates Tipping & Spilling.
- 8 Quart Capacity
- Lock - On Feature
- 10-1/4" x 10-1/2"
- 1-7/8" Spout
- 15 GPM Capacity.
- Fits All 3 Commonly Used Filler Necks. Equipped With Removable Fine Mesh Wire Screen

Funnel Complete
ORDER # TF123..... \$ 30.95

GREASE INJECTORS

Grease Injector Of Surgical Stainless Steel Allows Lubrication Of Sealed Bearings By Insertion Of Fine Tip Under Lip Of Bearings. Use With Standard Grease Gun Tip. ORDER # TGI110..... \$ 7.95



GREASE GUN & PARTS

Spring Fed 11" Barrel Grease Gun. Uses Standard 11" Grease Cartridge. Lever Handle Develops 10,000 Lbs Of Pressure. Grease Gun
ORDER # 4221081..... \$ 19.95



Gun Holder
ORDER # GC102..... \$ 10.95
Small Diameter



Snap On Coupler
ORDER # 42360..... \$ 7.95



GREASE HOSES PIPE & FLEXIBLE

There are cheaper hoses on the market, but why waste your money on those!

Synthetic oil resistant hose!
12" Flexible Grease Hose
ORDER # 422580..... \$ 6.95



18" Flexible Grease Hose
ORDER # 422582..... \$ 8.95

S M V EMBLEMS

Emblem
On Metal Back
ORDER # SMV1C \$ 12.95



Emblem
On Plastic Back
ORDER # SMV1PC \$ 12.95



Spade
Mounting ONLY
Does NOT Include
Socket (SMV5)
ORDER # SMV7 \$ 3.95



Mounting Socket
With Nuts & Bolts
For SMV7 Spade Mounting
ORDER # SMV5 \$ 3.50



Pole Mount
Assembly ONLY
ORDER # SMV6 \$ 6.95



WHEEL SPINNERS

Aluminum, Wheel Spinners Dip
Coated In Vinyl. Contains Brackets
For Regular & Deep Spoked Wheels

ALUMINUM
ORDER # WSVA \$ 8.95



BLACK
ORDER # WSV124B \$ 8.95



RED
ORDER # WSV122R \$ 8.95



BLUE
ORDER # WSV120B \$ 8.95



YELLOW
ORDER # WSV123Y \$ 8.95



GREEN
ORDER # WSV121G \$ 8.95



ORANGE
ORDER # WSV125OR \$ 8.95



MAGNETIC BLOCK HEATER

Magnetic
Block Heater,
115-120 Volt AC,
180 Watt, Draws 2 Amps
Maximum. Delivers 300-400
Degree Surface Temperature.
Includes 6' Cable And Instructions.
ORDER # MBH1153 \$ 62.95



DRAWBAR GRAB HOOK

Hot Forged Heat Treated
Hi - Strength Steel; 3/4" Body.
Fits: All Tractor Drawbars,
Old or new, Front Or Back, Up
To 1 1/2" Thick. Use With
Chain 5/16" or 1/2".
ORDER # B0834 \$ 26.95



CLEVIS GRAB HOOK

Size	ORDER #	Price
1/4"	213804	\$ 3.95
5/16"	213805	\$ 3.95
3/8"	213806	\$ 6.95
7/16"	213807	\$13.95
1/2"	213808	\$14.95



LOOSE PIN TYPE

Loose Pin Utility Clevises - Forges From
Hi - Strength Steel With Heat Treated
Alloy Pin.

Size	ORDER #	Price
1/4"	152-1546	\$ 3.95
5/16"	1521547	\$ 3.95
3/8"	1521548	\$ 4.95
7/16"	1521549	\$ 4.95
1/2"	1521550	\$ 6.95
5/8"	1521551	\$ 9.95



ALL PURPOSE CLEVIS

Hot - Forged - Heat
Treated Round Pin For
Extra Strength. 3/4"
Body Diameter. And Pin
Diameter
ORDER # B465 \$ 13.95



*We then that are strong ought
To bear the infirmities of the
weak and not to please
ourselves. Romans 15:1*

LIGHT SWITCHES

Heavy Duty Switch,
Plastic Knob,
1/2" Dia., Two Position
Vertical, Fused 20 Amps.
ORDER # L5067 \$ 12.95



Chrome Knob
Push - Pull,
2 Position Vertical, Not Fused
ORDER # L5011 \$ 9.95



Chrome Knob
Push - Pull,
Single Pole Vertical,
Non Fused For Grounded Frame
ORDER # L5031 \$ 9.95



WARNING LIGHTS

Replacement Lamps Assembly
With Two Amber Lenses,
Washers And Nut For Cab
Or Fender Mount
12 Volt Base Mount Complete
ORDER # L72512V \$ 16.95



RED LENS TAIL LAMP

Lamp Complete
with bulb.
Universal Bracket,
Black Enamel Finish,
3-3/4" Lens Diameter.
12 Volt Tail Lamp
ORDER # L42812V \$ 13.95



COMPACT TOOL BOX

Handy, Convenient,
Heavy Metal, with
Hasp.
Size 5" Depth,
5" Height
15" Width.
Four predrilled holes in
back to allow a variety of
mountings. No Brackets.
Red ORDER # TBR \$ 25.95
Blue ORDER # TBB \$ 26.95
Black ORDER # TBBK \$ 34.95
Gray ORDER # TBG \$ 26.95



RADIATOR GENIE

- Includes both air and water wands.
- Blow out radiators with air wand, wash out with the water wand.
- Reaches where nothing else can.
- Quickly and easily clean all your vehicles and equipment.
- Use the air wand to blow out Air Filters



ORDER # RG1004 \$36.95

UNIVERCO LOCK-ON GREASE COUPLER

The long lasting, reliable way to end greasing frustration.

UniverCo Lock-On Grease Coupler puts the FUN back into greasing your machinery and equipment!

"Old Style" lock-on grease coupler.

- Easy Lock-On and Release
- Does not drip
- 10,000 Max PSI Rating
- Smaller Barrel
- Ball-Lock Design
- Easy to use in small spaces



Large Barrel UniverCo Lock-On Grease coupler.

- Uses jaw grip locking design.
- Easy Lock-On and Release
- Does not drip
- 10,000 Max PSI Rating

Fits most grease guns and accessories

ORDER # UC3102 \$33.95

ORDER # UC2118..... \$33.95

Since 1976

Stevens
TRACTOR COMPANY

Hard to find tractor & implement parts are our specialty!

Give us a call at 1-800-333-9143.

Sport your favorite tractor with these customized Vintage Tractor Hats

Our tractor hats feature popular brands of antique tractors and are made of high quality materials.

Keep the sun off your face in style.

ONLY \$11.95

IH Red Mesh Hat



ORDER # HATIHRM

IH Solid Red Hat (No Mesh)



ORDER # HATIHSR

Oliver Vintage Logo Green Mesh



ORDER # HATVOGM

Minneapolis Moline Black and Gold (No Mesh)



ORDER # HATMMBG

Minneapolis Moline Black Mesh



ORDER # HATMMBM

Massey Ferguson Red Mesh



ORDER # HATMFRM

Allis Chalmers Orange and Black with Vintage AC Logo (No Mesh)



ORDER # HATVAOB

Order Information

How To Order From Stevens Tractor Ag Parts Catalog

PHONE TOLL FREE 1-800-333-9143 Hours Mon.- Fri. 7:30am - 5:00pm Sat. 7:30am - 12:00pm Central Standard Time	FAX 1-318-932-9800 24 Hours A Day This is much faster than by mail.	ORDER ONLINE WWW. stevenstractor .com	MAIL Mail Your Completed Order Form to: Stevens Tractor Co, LLC 3715 Hwy 71 Coushatta, LA 71019
---	---	---	--

Policies & Procedures From Stevens Tractor Co, LLC

PAYMENT

Credit Cards:

We honor Visa, Master Card, Discover, American Express and Farm Plan.
Please have your card present when placing your order. We will ask for Card Code Verification.



Checks:

You may send Check or Money Order, However please call for current prices before mailing your payment.
Any order received that has a balance due will NOT be shipped until paid in full. Please do NOT send cash or stamps.

Returned Checks:

Any personal check presented before us that is returned for (NSF) Non-Sufficient Funds, there will be a Returned Check Charge. If proper payment to Stevens Tractor has not been made within 14 days of the NSF check, then legal action will be pursued.

Additional Shipping Charges will be applied.
Dimensional Weight Charges
Ship via Freight (Commercial) Truck only

NO UPS C O D:

NO COD Orders. You may mail a check or money order in advance. We also accept all major credit cards.

SHIPPING

Federal Express (FEDX) will be used as the Common Carrier in most instances. Items exceeding size and weight limitations of FedX will be shipped freight collect by commercial truck line. UPS 2nd Day Air is Available. Call for 2nd Day Air rates. We also offer Smart Post via the US Postal Service for packages weighing up to 3lbs.

We NO Longer Use a Shipping Chart. Please CALL 1-800-333-9143 for actual shipping charges. Any Item of excessive size and weight will have additional shipping charges, such as fenders, mufflers, bumpers, fuel tanks, radiator shells. Not All items are marked in the catalog stating the additional shipping charges. **ALL items unable to be boxed will have an additional \$12.00 charge added in the shipping.** FedX and UPS delivers to physical addresses ONLY. Please! No Post Office Boxes.

DAMAGE Claims: All claims of damage or shortage must be made within 7 days of receipt. Please keep the merchandise in the original carton for the carrier to inspect. NO claims of damage or shortages accepted after 20 days.

RETURNED ITEMS

Please inspect the merchandise upon arrival. If you are not completely satisfied, please return merchandise PREPAID within 30 days. All merchandise to be returned must have Proper Authorization from Stevens Ag Parts. Please write, fax, or phone and tell us what you want to return and why you want to return it. You will be issued a **Return Authorization Number**. Please include a **copy of your invoice** and note the Return Authorization Number on the Invoice.

Returns must be in good resaleable condition (excluding defective items). Proper refund will be issued after merchandise has been received. A **35% restocking charge** will be made on all returns for reasons other than shipping error on our part or defective merchandise. Returns after 30 days may be subject to 50% Retocking fee or in some cases non-refundable. For no reason will merchandise be accepted after one year.

PARTS - PRICES & ERRORS

STC, LLC. Color photos in the catalog are for Catalog Purposes only and do not represent the actual color of the parts. Colors of the product vary from suppliers and availability. STC, LLC cannot be held responsible for any typographical errors that may be listed in this catalog or other catalogs. We have done our best to make sure that the information listed for each part is correct. Due to supplier price increases and decreases, **PRICES ARE SUBJECT TO CHANGE WITHOUT NOTICE!** Due to carrier rate increases, shipping costs are subject to change without notice. **Errors** - We are only human and we do make mistakes. Although we have tried very hard to correct all items, we apologize for any errors. We welcome your comments and suggestions.

Out Of Stock Items: It is our goal to ship all orders promptly as we receive them. Not all items pictured in our catalog are stocked. Sometimes due to heavy demands or supply problems, certain items must be back-ordered. We will make every effort to ship your order within thirty days or refund your money.

Parts: We offer **High Quality Replacement Parts**. OEM part numbers are used for reference only.

HOLIDAY'S CLOSED: New Years Day, Memorial Day, July 4th, Labor Day, Thanksgiving Day, Black Friday and Christmas.

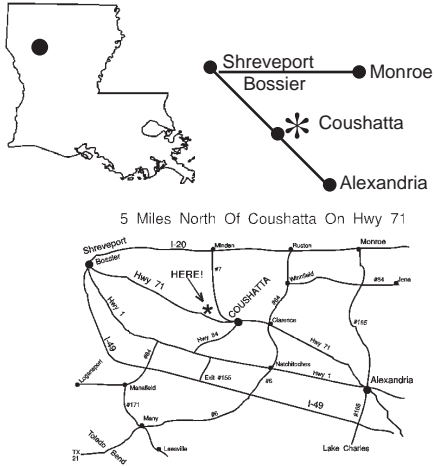

Stevens Tractor Company

3715 Hwy 71
Coushatta, Louisiana 71019

CATALOG CODE: E20

Or Current Resident



HEAVY DUTY ATV DISC

Pull with an ATV250cc or Larger Garden Tractor



IDEAL FOR FOOD PLOTS & GARDENING

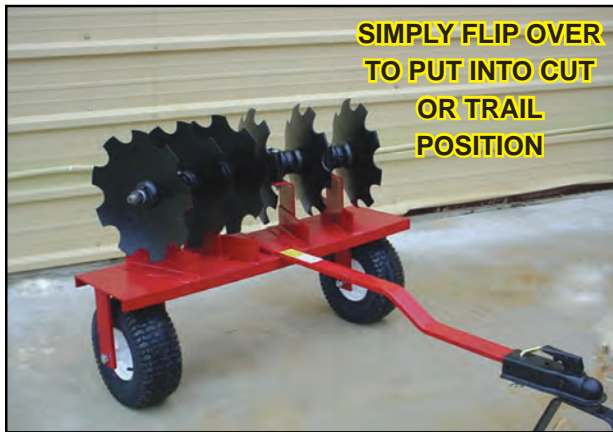

**SIMPLY FLIP OVER
TO PUT INTO CUT
OR TRAIL
POSITION**



Deep CUTTING Action

FEATURES

- HEAVY CHANNEL IRON CONSTRUCTION
- GREASEABLE CAST IRON BEARINGS
- LARGE TIRES 15" OD
- PRESET ANGLE FOR GOOD CUTTING ACTION
- 16" NOTCHED DISC BLADES
- MAKES SHARP TURNS WITHOUT TIRE HITTING TONGUE

TWO SIZES AVAILABLE

6 BLADE: Pull with a 250cc Bike or 16HP Garden Tractor. 4Ft. Wide. Weight 250 Lbs.

ORDER # ATVD \$ 625.00

8 BLADE: Pull with a 400 cc & Up. 5 Ft. Wide. Weight 285 Lbs.

ORDER # ATVD-5 \$ 725.00

* FREIGHT TRUCK SHIPMENT TO BUSINESS ONLY

CoCeaux says "Come check out our Farm Equipment to get your Garden Ready!"

Go check out our website at www.stevenstractor.com

OR Give us a call at 1-800-333-9143 and we'll get you set up!

